

CATALOGO ACCESSORI PER SCALE



Il presente catalogo può contenere particolari non aggiornati rispetto al momento di stampa.
Si prega di contattare il responsabile commerciale per eventuali elementi qui non presenti.

Si noti che l'ultimo inserimento riguarda gli accessori ora disponibili anche per tubo Ø 48

ACCESSORI PER RINGHIERE INOX

**SENZA SALDARE
FACILE E VELOCE
ASSEMBLAGGIO**



Via A. De Gasperi, 1-42016 GUASTALLA (RE) ITALY

Tel. 0039-0522-831205 Fax 0039-0522-831093 E-mail: duecinox@duecinox.it

TERMINOLOGIA

CORRIMANO A MURO



RINGHIERA

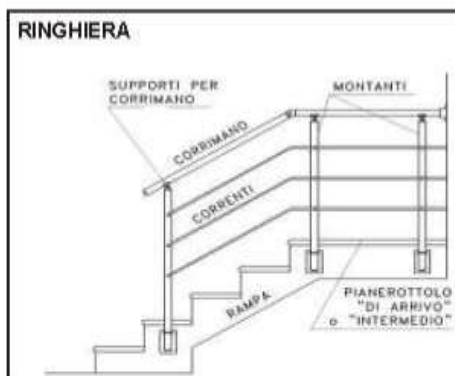

FISSAGGIO SU PEDATA O PAVIMENTO



FISSAGGIO SUL FIANCO



FORATURE

Per ANCORANTI UNIVERSALI e MECCANICI e CHIMICI su FORATO la profondità di foratura è di 1 cm (10mm) superiore alla profondità di inserimento del tassello o della rete (come da tabelle pag. seguente)

PER ANCORANTE CHIMICO SU MATERIALE COMPATTO

Su pedata o pavimento

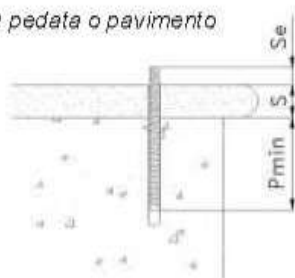

Sul fianco

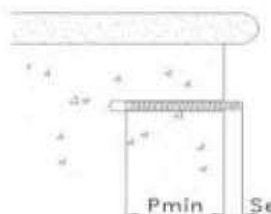

P_{min}	Minima profondità di ancoraggio nel supporto
Se	Sporgenza esterna per flangia e dado
S	Spessore del rivestimento

N.B: Le lunghezze delle barrette di nostra fornitura sono tali da superare o rispettare **P_{min}** utilizzando i nostri accessori, purchè il rivestimento **S** sia inferiore al valore dato in tabella a pag.5. In caso contrario richiedere le barrette di lunghezza necessaria o richiedere la barra L=1000mm da tagliare in opera (Pag.33)

Ø Barretta	P_min (mm)
M 6	50
M 8	65
M 10	80
M 12	95

BARRETTE PER ANCORAGGIO CHIMICO*

* Vedi anche pag.51

USARE con:

AC1 per ambienti umidi o all'esterno

AC2 per interni

BA (rondella e dado se con copriflangia)

BAC (rondella e dado cieco senza copriflangia)

N.B: Per supporti compatti e lontano dai bordi è possibile usare gli **ancoranti meccanici** preferiti o scelti tra i nostri disponibili e usati secondo le modalità suggerite nelle pagine seguenti.

- Misure delle Barrette consigliate per i nostri articoli.
- Diametri ($\varnothing f$) e profondità minime (P) dei fori.
- Spessori S_{max} dell'eventuale rivestimento compatibile con le lunghezze delle barrette consigliate. Quando lo spessore dell'eventuale rivestimento è superiore occorre richiedere barrette più lunghe o la barra da 1,00 mt da tagliare secondo necessità.

ARTICOLO Nr.	Q.TA'	SUPPORTO COMPATTO				SUPPORTO FORATO			
		BARRETTA	$\varnothing f$	P	S_{max}	RETE - BARRETTA	$\varnothing f$	P	S_{max}
010-011-012	3	BA/BAC 898	10	95	15	R12+BA/BAC 898	12	95	15
020-021-030-060-070	3	BA/BAC 898	10	95	18	R12+BA/BAC 898	12	95	18
043	1	BA898	10	90	13	R12+BA 898	12	95	13
090-100	3	BAC 695	8	95	32	R12+BAC 898	12	95	32
101	4	BAC 898	10	95	18	R12+BAC 898	12	95	18
102	2	BAC 10100	12	95	5	R16+BAC 10100	16	95	5
103	2	BAC12115	14	105	-	R20+BAC 12115	20	140	-
110-035-040-041	Ancoranti Universali UX85								
INOX FLEX	Ancoranti Universali UX86								

ANCORAGGIO PAVIMENTO-PARETE



ANCORAGGIO MECCANICO/CHIMICO

Con questo simbolo si indica che l'ANCORANTE UNIVERSALE più idoneo è già compreso nell'articolo/Kit.

In mancanza, l'ancorante non è compreso e può essere scelto tra i disponibili (vedi pag. 7-50-51) tenendo presente le indicazioni della tabella in questa pagina e pag. 6-7

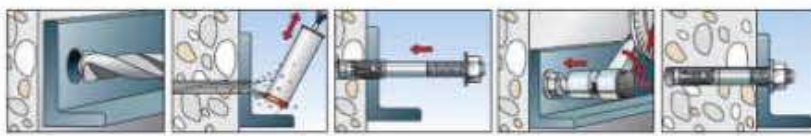
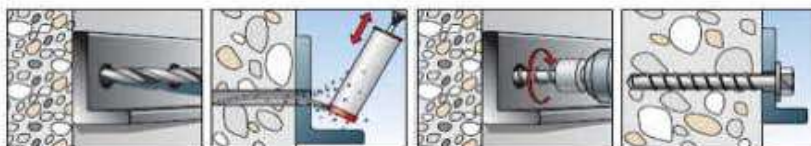
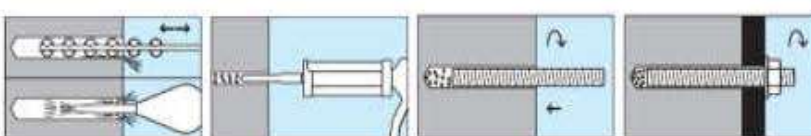
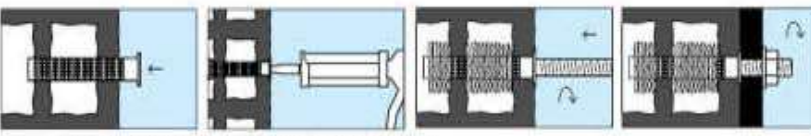

SISTEMI DI FISSAGGIO

TIPOLOGIA ANCORANTI	A datti per supporti...	SEQUENZA DI MONTAGGIO
UNIVERSALI (UX8)	<ul style="list-style-type: none"> - COMPATTI - FORATI - A PARETE SOTTILE 	 <p style="font-size: 0.8em; text-align: center;">Si raccomanda un'accurata pulizia del foro prima dell'installazione.</p>
	<div style="display: flex; align-items: center;"> <div style="writing-mode: vertical-rl; transform: rotate(180deg); font-size: 0.8em; margin-right: 5px;">(T18) (T28)</div> <div style="margin-left: 10px;"> <p style="margin: 0;">COMPATTI</p> <p style="margin: 0;">lontano dai bordi</p> </div> </div>	 <p style="font-size: 0.8em; text-align: center;">Si raccomanda un'accurata pulizia del foro prima dell'installazione.</p>
MECCANICI (TAB-T18-TE8)	<div style="display: flex; align-items: center;"> <div style="writing-mode: vertical-rl; transform: rotate(180deg); font-size: 0.8em; margin-right: 5px;">(TA)</div> <div style="margin-left: 10px;"> <p style="margin: 0;">COMPATTI</p> </div> </div>	 <p style="font-size: 0.8em; text-align: center;">Si raccomanda un'accurata pulizia del foro prima dell'installazione.</p>
	<p style="margin: 0;">COMPATTI</p> <p style="margin: 0;">con "BA" (Barretta)</p>	 <p style="font-size: 0.8em; text-align: center;">Si raccomanda un'accurata pulizia del foro prima dell'installazione.</p>
CHIMICI (AC1) (AC2)	<p style="margin: 0;">FORATI</p> <p style="margin: 0;">con: "R" (Rete) + "BA" (Barretta)</p>	 <p style="font-size: 0.8em; text-align: center;">Si raccomanda un'accurata pulizia del foro prima dell'installazione.</p>
	<p style="margin: 0;">Come inserire la BARRETTA con DADO CIECO "BAC"</p> <ol style="list-style-type: none"> 1 Preparare le BARRETTE necessarie complete di rondella e dado cieco <i>avvitato</i> fino in fondo e <i>svitato</i> di 2-3 giri necessari per il serraggio. 2 Nei fori già puliti iniettare il prodotto AC1 o AC2 e posizionare la flangia. 3 Inserire le barrette sino in battuta e tenere in posizione per il tempo di indurimento (4-10 min. v. tabella del prodotto). 4 Serrare i dadi dopo il tempo di applicazione (45-90 min., v. tabella del prodotto) 	
 Fischer Italia nostro partner di fiducia		

ANCORANTI DISPONIBILI*

* Vedi anche pag.50-51

UNIVERSALE



Lt = lunghezza tassello mm
 of = diametro punta mm
 P = profondità minima foro mm
 Sp = spessore minimo supporto mm
 S = spessore max fissabile mm
 ov = diametro vite mm
 Lv = lunghezza vite mm

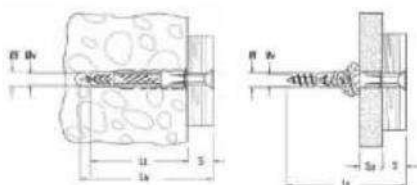

Tassello universale in nylon con vite inox adatto a qualsiasi supporto compatto o forato e pareti di sp> 10mm.

Con vite: M5x60 M6x60 **UX8**

Lt=50 Øf=8 P=60

MECCANICO



of = diametro punta mm
 P = profondità minima foro mm
 hv = prof. min ancoraggio mm
 S = spessore max fissabile mm
 ov = diametro vite mm

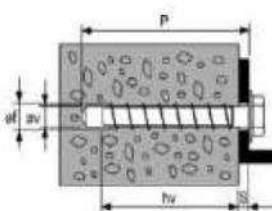

Vite autofilettante in acciaio zincato con testa esagonale. Adatto a supporti compatti anche vicino (5 cm.) ai bordi essendo privo di espansione

TA

vedi pag.50

MECCANICO



Lt = lunghezza ancorante mm
 of = diametro punta mm
 P = profondità minima foro mm
 hv = prof. min ancoraggio mm
 S = spessore max fissabile mm
 ov = diametro vite mm
 Ch = chiave
 M = coppia di serraggio Nm
 or = diametro rondella mm
 Sr = spess. rondella mm

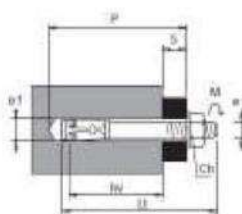

Adatto ai supporti compatti. Installazione semplice e veloce con pochi giri di avvitamento

TZ8

TI8

indoor vite in acciaio Lt=75 Øf=8 P=75
outdoor vite in inox Aisi 316

CHIMICO



AC1
 con due miscelatori



APPLICAZIONE: Indoor-Outdoor

- ✓ Utilizzabile con pistola da silicone
- ✓ Per carichi pesanti
- ✓ Idoneo per applicazioni su fori umidi e su fori a contatto continuativo con acqua
- ✓ Resistente alle alte temperature (+120°C)
- ✓ Resistente ai cicli di gelo/disgelo e all'umidità

Supporti:

- Pieni (calcestruzzo, pietra, mattone pieno)
- Forati (poroton, doppio UNI, blocchi cavi)
- Legno



AC2
 con due miscelatori



APPLICAZIONE: Indoor

- ✓ Utilizzabile con pistola da silicone
- ✓ Per carichi medio-pesanti
- ✓ Resistente alle sostanze aggressive quali acidi e basi
- ✓ Ottima tixotropia, non cola.
- ✓ Non idoneo per applicazioni a contatto con acqua e/o umidità

Supporti:

- Pieni (calcestruzzo, pietra, mattone pieno)
- Forati (poroton, doppio UNI, blocchi cavi)

Per supporti compatti:

Barretta tutto filetto



Per supporti forati:

Tasselli a rete R + barrette tutto filetto BA o BAC



Fischer Italia nostro partner di fiducia

COLLEGAMENTO ACCESSORI CON VITI

VITI

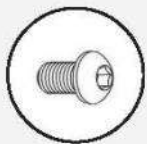

Questo simbolo indica che le viti necessarie ai collegamenti **sono comprese** nella fornitura.



COMPRESO

Viteria compresa nella fornitura dell'articolo

COLLEGAMENTO ACCESSORI CON TUBO

Per collegare i sostegni corrimano al corrimano stesso:

1. **FORATURE** con punta per inox (corta) secondo i diametri riportati nella tabella qui a fianco
2. **MASCHIATURA** dei fori con maschi per inox
3. **APPLICAZIONE** dell'accessorio con viti allegate.



FILETTO VITE	Ø PUNTA
M 4	3,3
M 5	4,2
M 6	5,0

Per applicazioni **SERRAVETRO** e **SOSTEGNI TONDO** sui montanti è consigliabile utilizzare **INSERTI IM8** e **IM6** (codice IM8 e IM6 pag. 52) oppure rullare il foro ottenuto per Fusione. Quest'ultima tecnica è da noi impiegata utilizzando macchine dedicate.

Applicazioni sui Montanti

FORATURA PER FUSIONE DEL MATERIALE (ottenuta con utensili e macchine dedicate) e **RULLATURA** del filetto (Fig.1)

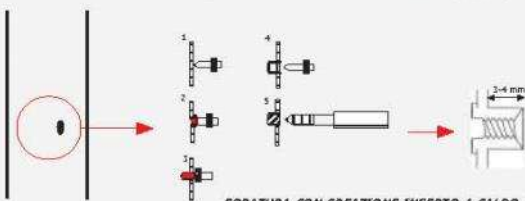

Fig. 1

FORATURA CON CREAZIONE INSERTO A CALDO

FORATURA PER INSERIMENTO INSERTO e applicazione dello stesso con attrezzo relativo (Fig.2)

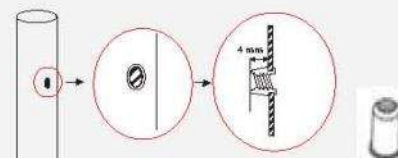
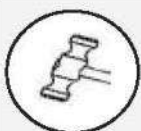

Fig. 2

FORATURA E ALLOGGIO INSERTO FILETTATO INOX



ALLOGGIO IN SEDE CON MAZZETTA DI GOMMA

Applicazione riservata ai terminali dei corrimano (*Tappi e calotte pag. 28*) e ad alcuni tipi di supporti corrimano, come gli elementi INOX-Flex (*pag. 23*).

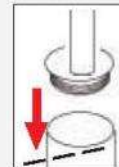

PERCUSSIONE



UNIONE MEDIANTE ADESIVI STRUTTURALI

Nel caso dei nostri accessori la giunzione con adesivo (*pag. 52*) è riservata esclusivamente alle unioni: canotto-interno tubo e si esegue come di seguito illustrato

Questo simbolo indica sempre il nostro Art. 320



ADESIVO



ESEMPI DI COLLEGAMENTI

- CON PERCUSSIONE
- CON ADESIVO
- CON VITI



ISTRUZIONI PER ASSEMBLAGGIO CON ADESIVO PER INOX Art.320

1. Taglio del tubo a misura perpendicolarmente al suo asse.
2. Eliminazione delle bave sugli spigoli interni ed esterni facendo attenzione a non segnare lo spigolo esterno.
3. Premontaggio di controllo della struttura.
4. Pulitura delle superfici da unire (esterne ed interne) con apposito solvente o acetone.



1



2



3



4



5



6



7



8

5. Applicazione di un cordoncino di adesivo all'interno del tubo e, possibilmente, anche lungo la circonferenza dell'estremità del canotto.
6. Introduzione del canotto con movimenti rotatori e lineari alternati in modo da distribuire l'adesivo uniformemente su tutta la superficie di contatto. Togliere con un panno eventuali fuoriuscite di adesivo.
7. Posizionamento della struttura nella sua posizione definitiva e attesa fino a 24h per il raggiungimento del 100% della forza di adesione. L'indurimento e il fissaggio dell'adesivo viene accelerato dal calore (Es: a 40°C la resistenza finale si raggiunge in 3 ore). Nei mesi estivi, con tubi esposti ai raggi solari, dopo pochi minuti non è più possibile modificare la giunzione.
8. Pulizia finale della struttura con "SPRAY PULIACCIAIO" Art. 321 (Vedi pag.52)

ADESIVO LIQUIDO PER ACCIAIO (Descrizione e caratteristiche principali)

L'adesivo raccomandato è il nostro Art. 320 (pag. 52) contenuto in flaconcini da 50 ml cadauno.

Scheda dati tecnici (TDS) fornibile su richiesta.

Conservazione: Conservare il prodotto nel contenitore chiuso in luogo asciutto non esposto ai raggi diretti del sole e/o altre fonti di calore.

Stoccaggio a lungo termine ottimale da 8°C a 21°C.

Lo stoccaggio a temperature inferiori a 8°C e superiori a 28°C può inficiare le performances del prodotto.

Precauzioni: Usare in ambiente ventilato, evitare il contatto con pelle ed occhi. Dopo utilizzo lavare le mani con acqua e sapone.



Art. 320

TECNOLOGIA	Acrilica
NATURA CHIMICA	Metacrilato uretanico
ASPETTO	Liquido verde
COMPONENTI	Monocomponente - non richiede miscelazione
VISCOSITA'	Alta
POLIMERIZZAZIONE	Anaerobica
APPLICAZIONE	Bloccante
RESISTENZA MECCANICA	Alta

ESEMPI DI APPLICAZIONI
SPACCATI E DETTAGLI ARTICOLI

SCALA DA INTERNO

Tubo satinato Scotch Brite 42,4 mm sp. 2mm
Tondo pieno D. 12 mm



Art. 103D42 - Serramontante piastra tonda (42,4)



Art. 101 - Serramontante (42,4)



Art. 130D42 Calotta inox-PVC
bom beta (42,4)



Art. 142D42 Calotta piana (42,4)



Art. 241 - Articolazione per montante (42,4)



Art. 312D42 - Sostegno per tondo D. 12 mm (Fissaggio con vite non passante)



Art. 244D4242 - Asta con snodo (42,4)

RINGHIERA SCALA ESTERNA

Art. 251 - Snodo a tre vie (42,4)



Art. 240 - Articol. per montante (42,4)



Art. 090 - Piastra laterale corta (42,4)



Art. 250D42 - Giunto a snodo (42,4)



Art. 100 - Piastra laterale lunga (42,4)



BALAUSTRATA in VETRO



Art. 210D42 - Tee (42,4)



Art. 230 - Sella (42,4)



Art. 190D42 - Gomito a tre vie (42,4)



Art. 020D42 - Piastra (42,4)

Art. 262D - Serravetro inox Aisi 316



Art. 029D42 - Copertura piastra (42,4)



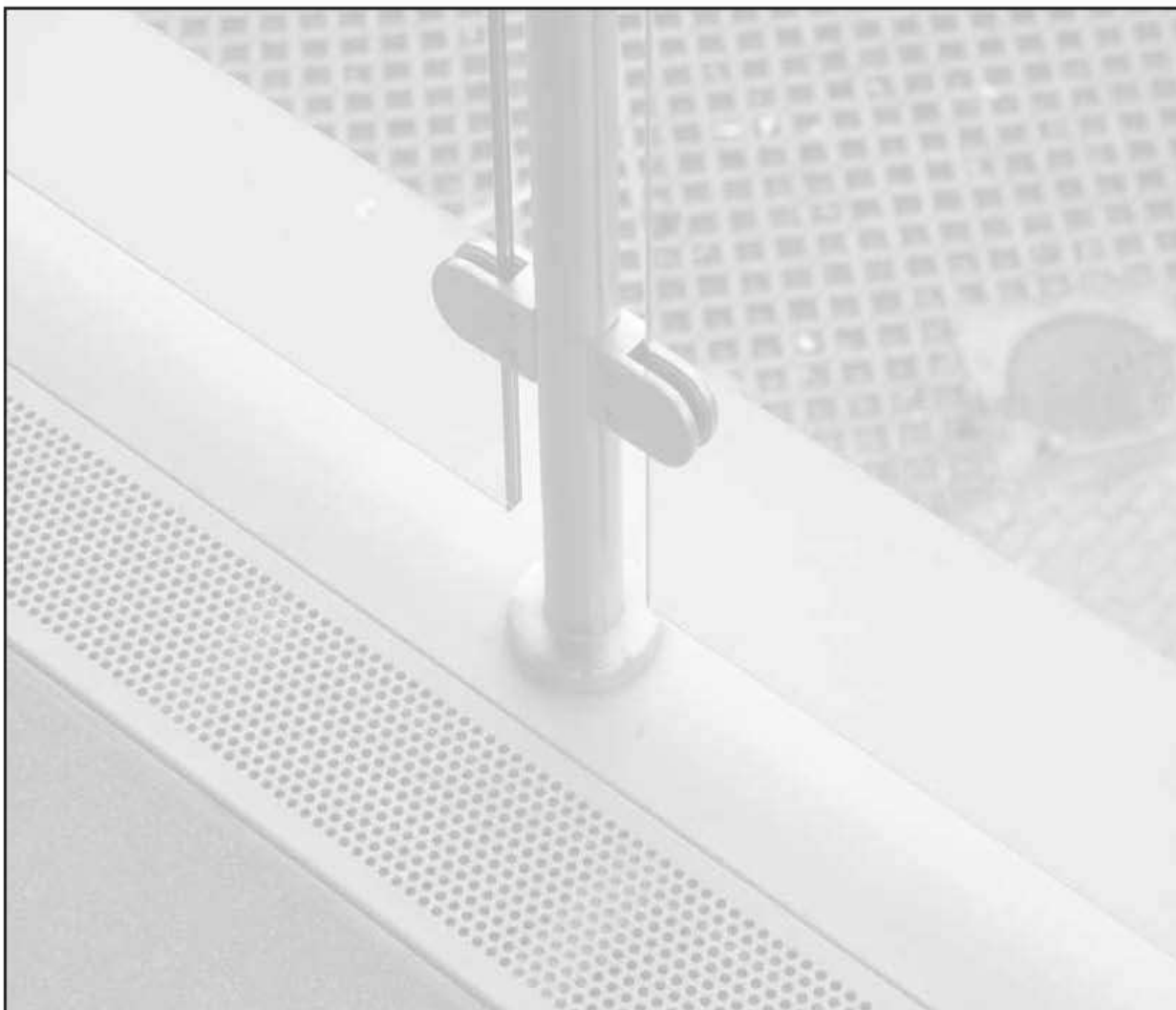

1

BASI DI FISSAGGIO PAVIMENTO-PARETE



**-FISSAGGIO PAVIMENTO-PARETE
-SUPPORTI E RACCORDI PER CORRIMANO**

Sistema professionale veloce e sicuro di composizione e fissaggio di strutture protettive (parapetti, ringhiere, corrimano, etc..)

Raccordi per tubolari $\varnothing 33,7$ - $\varnothing 42,4$ - $\varnothing 48,3$ di spessore 2,0mm (vedi sezione TUBIE BARRE a pag.32)

I raccordi si fissano al tubo con viti o con adesivo senza dover mettere in preventivo dispendiosi (tempo e denaro) interventi di saldatura e pulitura !

**NO SALDATURE !!
NO MANUTENZIONE !!**

Piastre di fissaggio-montanti ringhiere 1



Piastre di Fondo Ø120mm

Art. No.	D	Ø Tubolare
010	120	42,4 x 2,0

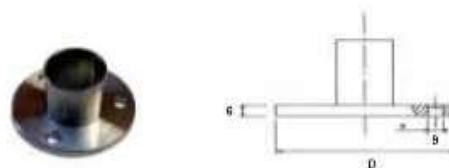

Piastre di Fondo Ø80mm

Art. No.	D	Ø Tubolare
020D33	80	33,7 x 2,0
020D42	80	42,4 x 2,0

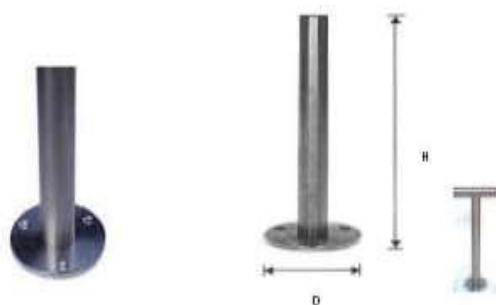

Montante completo di Piastra Ø120mm

Art. No.	D	H tot.	Ø tubolare
011	120	1200	42,4 x 2,0



Montante completo di Piastra Ø80mm

Art. No.	D	H tot.	Ø tubolare
012D33	80	1200	33,7 x 2,0
012D42	80	1200	42,4 x 2,0



Attacco a muro con snodo

Art. Nr.	Ø
021	42,4x2,0



Piastre appoggio murale

Art. Nr.	Ø	D	H
035D33	33,7	85	30
035D42	42,4	95	30
035D48	48,3	100	35

KIT completo

035D33K	ancoranti universali UX85
035D42K	ancoranti universali UX85
035D48K	ancoranti universali UX85



1 Flange e copripiastre



Flangia Ø 70 mm

Art. Nr.	Nr. fori	Aisi
D4H3	3	304
D6H3	3	316



Flangia Ø 70 mm

Art. Nr.	Nr. fori	Aisi
D4L3	4	304
D6L3	4	316

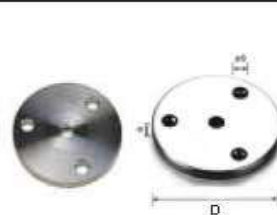

Flangette

Art. No.	D
060	60
070	80

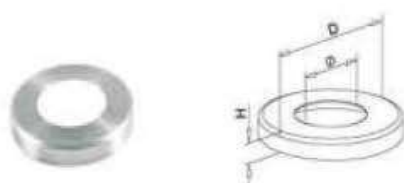

Copertura per Piastra

Art. No.	D	Ø	H	Utilizzo
019	125	42,4	16	Art. 010-011
029D33	85	33,7	13	Art. 020D33-012D33
029D42	85	42,4	13	Art. 012D42-020D42



Copertura per Flangette

Art. No.	D	Ø	H	Utilizzo
049	85	14,5	17	Art. 070
050	76	14,5	12	Art. D4M/N
065	70	12,5	13	Art. 060
075	70	14,5	13	Art. 060

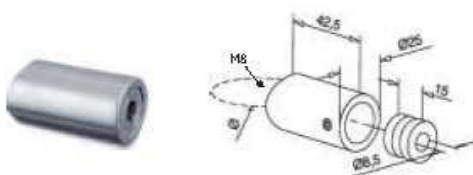

Attacco murale per corrente

Art. Nr.	Ø
025D33	33,7
025D42	42,4



Piastra di appoggio

Art. Nr.	Ø	F	C	A
110	42,4	Ø76	17	30

KIT completo

110K	ancorante universale UX85 e vite 593106x16
------	--

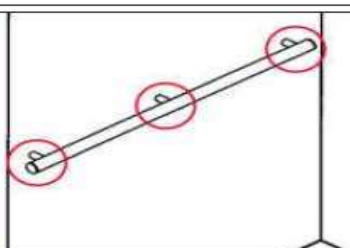
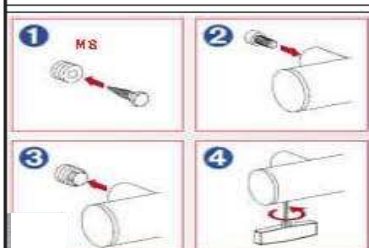

Raccordi murali-pavimento 1

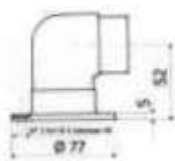

Piastra laterale corta

Art. Nr.	Ø
090	42,4x2,0

Piastra laterale lunga

Art. Nr.	Ø
100	42,4x2,0

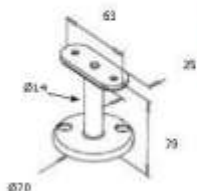

Supporto PIATTO due fori "DM"

Art. nr.	Fori	Aisi
D4M21	2x9	304
D6M21	2x9	316

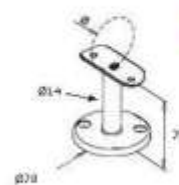

Supporto due fori "DM"

Art. nr.	Ø Corrimano	Aisi
D4M121	33,7	304
D6M121	33,7	316
D4M221	42,4	304
D6M221	42,4	316
D4M322	48,3	304
D6M322	48,3	316

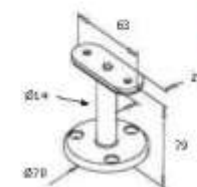

Supporto PIATTO tre fori "DN"

Art. nr.	Fori	Aisi
D4N21	3x7	304
D6N21	3x7	316

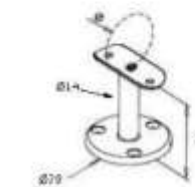

Supporto tre fori "DN"

Art. nr.	Ø Corrimano	Aisi
D4N121	33,7	304
D6N121	33,7	316
D4N221	42,4	304
D6N221	42,4	316
D4N322	48,3	304
D6N322	48,3	316



VITERIA SUGGERITA (non compresa)



ANCORANTI SUGGERITI (non compresa)

1 Raccordi per fissaggio montanti a parete

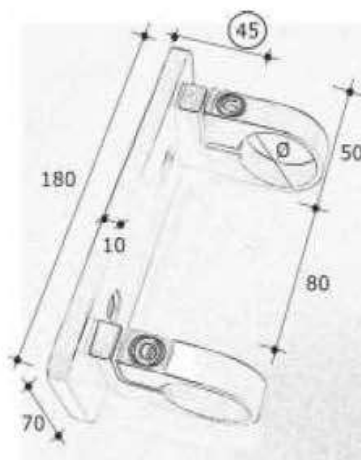

*Sostituisce il vecchio Art. 101

Serramontante rettangolare (70x180)

Art. Nr.	Ø
105D33	33,7
105D42	42,4
105D48	48,3



Ø42,4

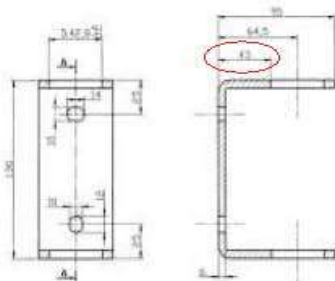

Ø33,7

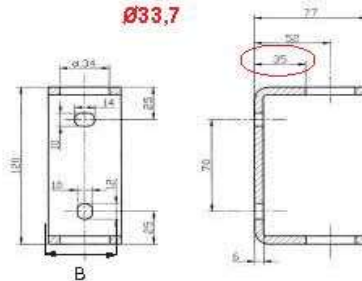

Serramontante rettangolare piccolo

Art. Nr.	Ø	B
102D33	33,7	50
102D42	42,4	60



ART. 105

Fissaggio tubo tramite serraggio con brugola dei due anelli morsetti.



ART. 102

Fissaggio tubo tramite saldatura ai due anelli.



Raccordi per fissaggio montanti a parete 1

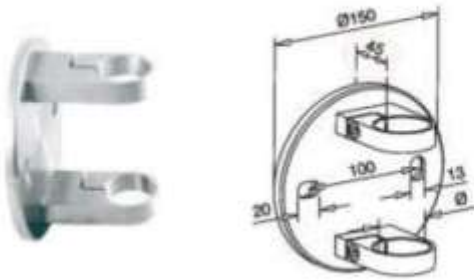

Serramontante tondo Ø150

Art. Nr.	Ø	Ø Piastra
103D33	33,7	150
103D42	42,4	150
103D48	48,3	150

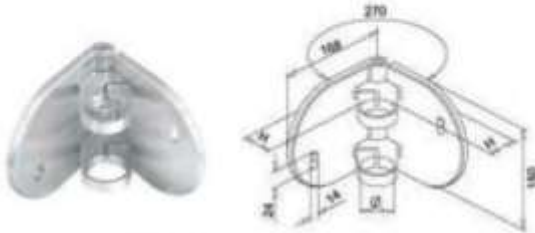

Serramontante tondo angolare

Art. nr.	Ø	H
106D42	42,4	45

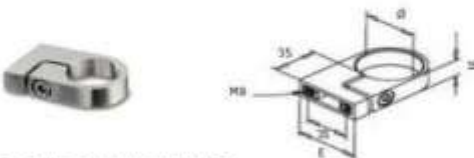

Anello serramontante

Art. Nr.	Ø	E
104D33	33,7	45
104D42	42,4	50
104D48	48,3	55



ART. 106D42

Piastra laterali serramontante tonde per angoli (concavo/convesso).
Nelle applicazioni con Art. 103D42



OGGETTO

Piastra laterali serramontante tonde



FUNZIONALITA'

Il sistema è strutturato in due anelli di serraggio (Art. 104D33-104D42) che vengono fissati al piastrone tondo di rinforzo. Il montante scorre al loro interno venendo fissato all'altezza desiderata tramite vite di serraggio.

APPLICAZIONI

Nei fissaggi con nr.2 ancoranti alla soletta esterna (vedi pag.50-51)

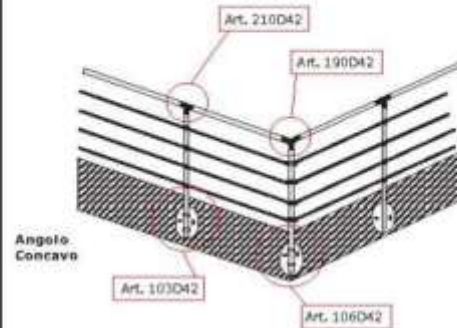

Angolo Concavo

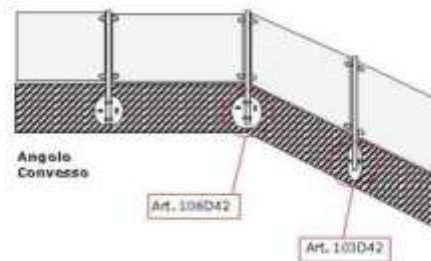

Angolo Convesso





2

SUPPORTI E RACCORDI PER CORRIMANO

- SUPPORTI PER CORRIMANO
- SERIE INOX-*flex*
- RACCORDI DI COLLEGAMENTO
- CALOTTE E TAPPI TERMINALI



Sistema professionale veloce e sicuro di composizione e fissaggio di strutture protettive (parapetti, ringhiere, corrimano, etc..)

Raccordi per tubolari Ø33,7-Ø42,4-Ø48,3 di spessore 2,0mm (vedi sezione TUBI E BARRE a pag.32)

I raccordi si fissano al tubo con viti o con adesivo senza dover mettere in preventivo dispendiosi (tempo e denaro) interventi di saldatura e pulitura !

NO SALDATURE !!
NO MANUTENZIONE !!

Supporti corrimano 2

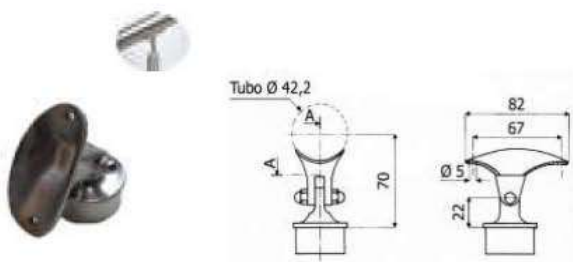

Attacco a snodo

Art. Nr.	Ø
240	42,4x2,0

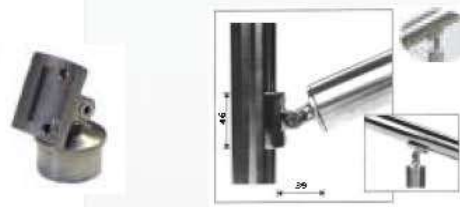

Articolazione per montante

Art. Nr.	Ø
241	42,4x2,0

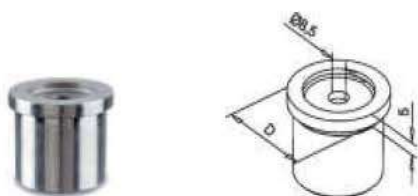

Supporto murale con foro Ø8,5

Art. Nr.	D
023D33	Ø33,7x2,0
023D42	Ø42,4x2,0
023D48	Ø48,3x2,0



Sella con foro Ø8,5

Art. Nr.	Ø	D
232	33,7	Ø33,7x2,0
234	42,4	Ø42,4x2,0
234D48	48,3	Ø48,3x2,0
RIDUZIONE-Corrimano Ø42,4 su Piantone Ø33,7		
235	42,4	Ø33,7x2,0



Supporto murale con foro filettato

Art. Nr.	D	S
022	Ø42,4x2,0	3



Sella rinforzata

Art. Nr.	E	B	C	D	A
230	Ø42,4x2,0	13	20	9,5	20

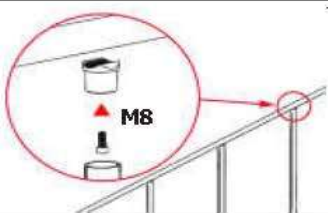

ISTRUZIONI MONTAGGIO SELLA



Gli **Art. 230-235** vengono impiegati per collegare i montanti verticali al corrimano orizzontale o per formare una o più derivazioni orizzontali su un montante verticale, costituendo un'alternativa all'**Art. 210** (Pezzo a Tee). La sella viene fissata al tubolare con vite dopo aver forato e filettato **M8** il tubo stesso. Successivamente viene incollato il canotto al tubo corrispondente.

2 Supporti corrimano

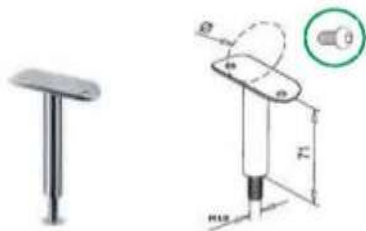

Perno M10 con piastra fissa

Art. Nr.	Ø
046F	Piatto
046D33	33,7
046	42,4
046D48	48,3



Base supporto per perno M10

Art. nr.	Ø
044D33	33,7x2,0
044D42	42,4x2,0
044D48	48,3x2,0

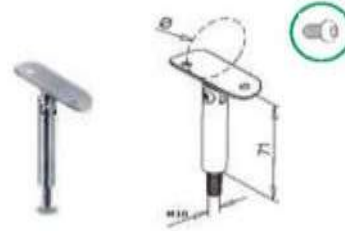

Perno M10 con piastra snodata

Art. Nr.	Ø
045F	Piatto
045D33	33,7
045	42,4
045D48	48,3

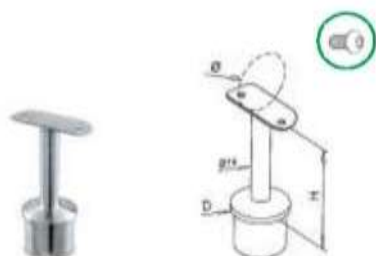

Asta fissa per corrimano

Art. Nr.	Ø	D	H
243D33/F	Piatto	33,7x2,0	80
243D42/F	Piatto	42,4x2,0	81
243D48/F	Piatto	48,3x2,0	82
243D33/33	33,7	33,7x2,0	78
243D42/42	42,4	42,4x2,0	79
243D48/48	48,3	48,3x2,0	80

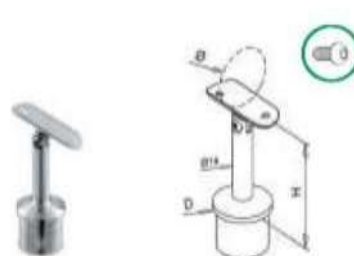

Asta con snodo per corrimano

Art. Nr.	Ø	D	H
244D33/F	Piatto	33,7x2,0	80
244D42/F	Piatto	42,4x2,0	81
244D48/F	Piatto	48,3x2,0	82
244D33/33	33,7	33,7x2,0	78
244D42/42	42,4	42,4x2,0	79
244D33/42	42,4	33,7x2,0	79
244D48/48	48,3	48,3x2,0	80



VITERIA COMPRESA



Supporti corrimano 2

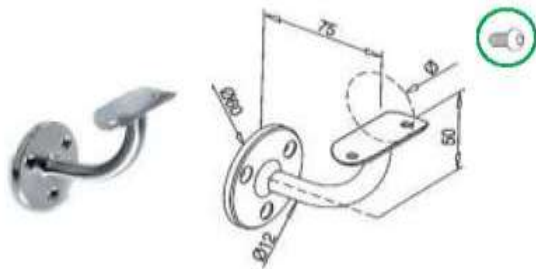

Sostegno a muro fisso

Art. Nr.	Ø	Base
040D33	33,7	Ø60
040D42	42,4	Ø60
KIT inox	completo di:	
040D33KX	viti 738005x10 e ancoranti UX85	
040D42KX	viti 738005x10 e ancoranti UX85	
KIT legno	completo di:	
040D33KW	viti 798105x25 e ancoranti UX85	
040D42KW	viti 798105x25 e ancoranti UX85	

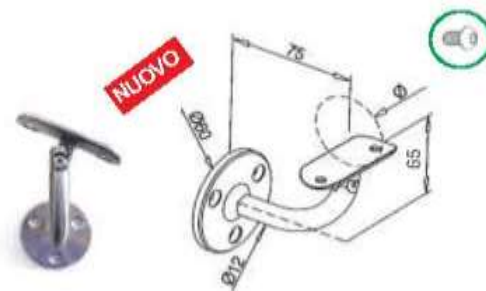

Sostegno a muro con snodo

Art. nr.	Ø	Base
041D33	33,7	Ø60
041D42	42,4	Ø60
KIT inox	completo di	
041D33KX	viti 738005x10 e ancoranti UX85	
041D42KX	viti 738005x10 e ancoranti UX85	
KIT legno	completo di	
041D33KW	viti 798105x25 e ancoranti UX85	
041D42KW	viti 798105x25 e ancoranti UX85	



Supporto pieno a muro fisso

Art. Nr.	Ø	Base
043F	PIATTO	Ø60
043D33	33,7	Ø60
043D42	42,4	Ø60



Mezzo guscio d'appoggio

Art. Nr.	Appoggio
080	Ø42,4

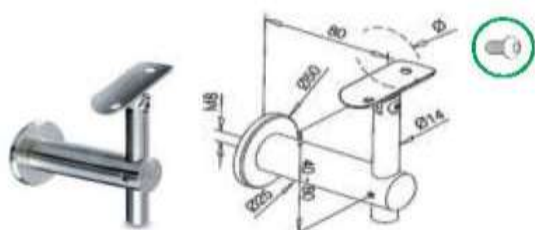

Supporto a muro con snodo per corrimano

Art. nr.	Ø
246	42,4

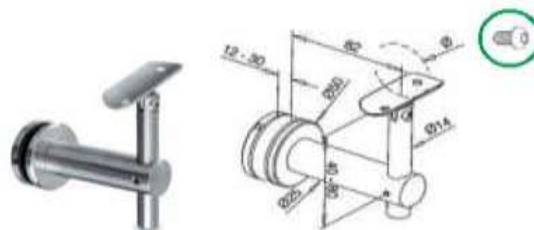

Supporto a vetro con snodo per corrimano

Art. nr.	Ø
249	42,4

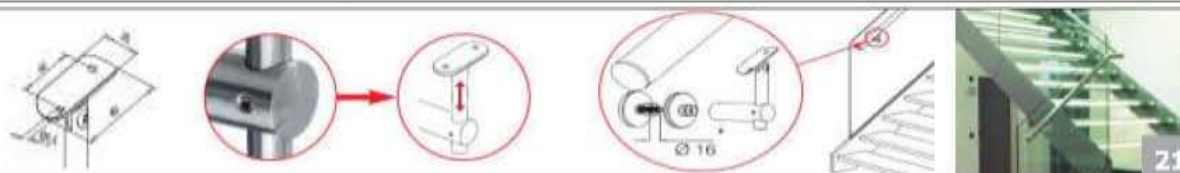

Supporti corrimano regolabili 2

Serie di Supporti (Tubolari, murali e su pannello in vetro) regolabili e inclinabili per ringhiere e barriere disassate
ANTI-SCAVALCAMENTO

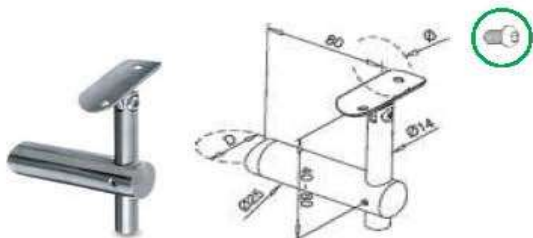

Supporto con snodo per corrimano

Art. nr.	Ø	D
245	42,4	Ø42,4

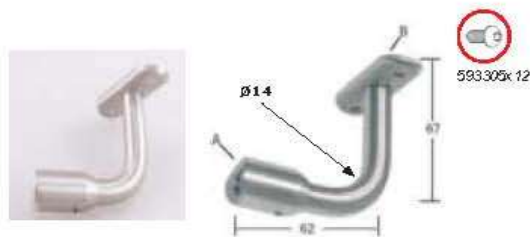

Supporto fisso per corrimano

Art. nr.		A	B
Aisi 304	Aisi 316		
4EB0	6EB0	Ø42,4	Piatto
4EB30	6EB30	Ø48,3	Piatto
4EB1	6EB1	Ø42,4	Ø33,7
4EB2	6EB2	Ø42,4	Ø42,4
	6EB3	Ø48,3	Ø42,4

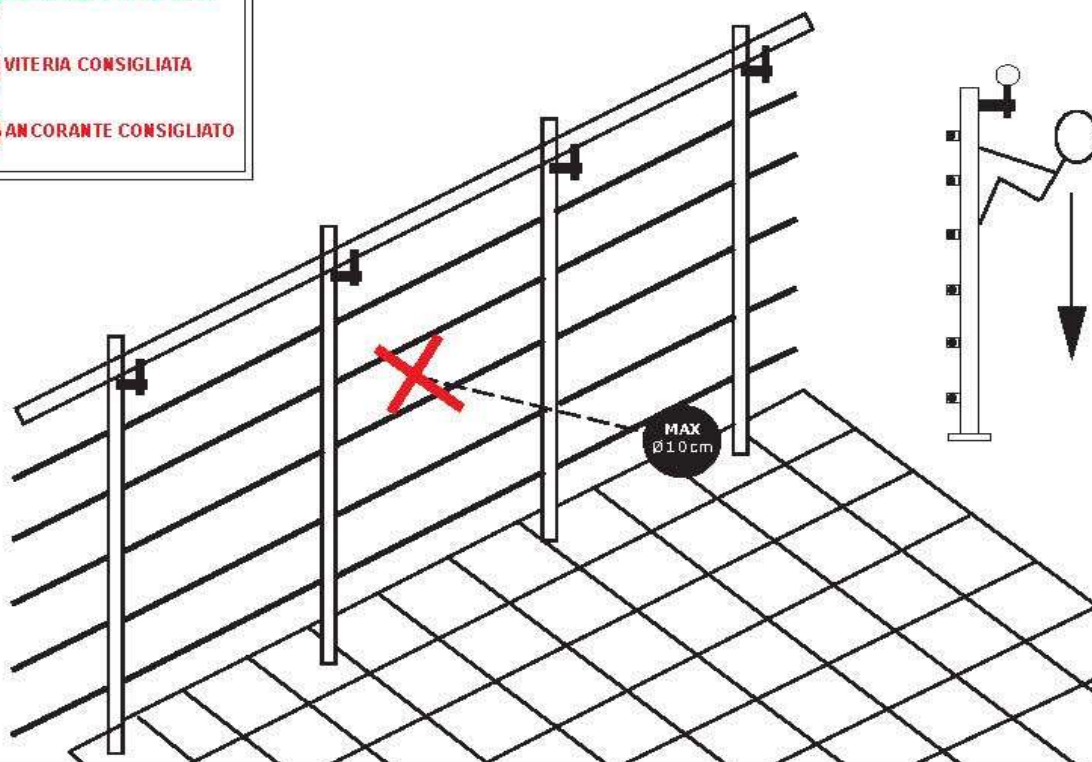

NORMATIVA ITALIANA PER LA SICUREZZA

La normativa italiana permette la realizzazione di barriere composte da elementi orizzontali (tubo, cavo, tondo, etc..) usando però i seguenti accorgimenti:

1. Infittire le linee della ringhiera in modo che una Sfera di Ø10cm non passi attraverso
2. Adottare supporti corrimano disassati, fuori asse ringhiera in modo che il peso stesso della persona eviti di arrampicarsi e oltrepassarla.

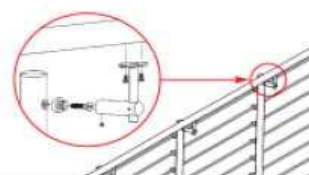

INOX-flex serie componibile 2

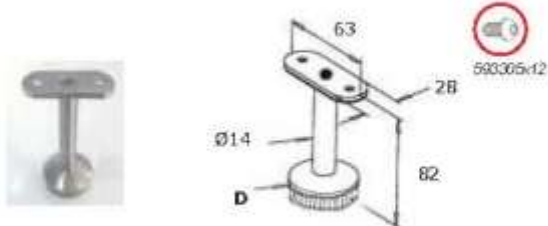

Supporto corrimano fisso "DA"

Art. Nr.		D	Ø
Aisi 304	Aisi 316		
4DA1023	6DA1023	33,7x2,0	Piatto
4DA2023	6DA2023	42,4x2,0	Piatto
-	6DA3023	48,3x2,0	Piatto

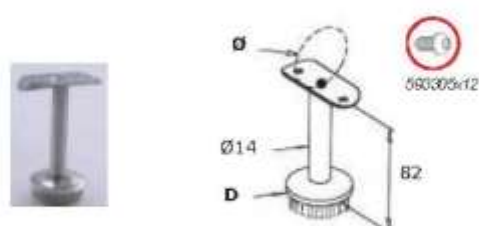

Supporto corrimano fisso "DA"

Art. Nr.		D	Ø
Aisi 304	Aisi 316		
4DA1123	6DA1123	33,7x2,0	33,7
4DA1223	6DA1223	33,7x2,0	42,4
4DA1323	6DA1323	33,7x2,0	48,3
4DA2123	6DA2123	42,4x2,0	33,7
4DA2223	6DA2223	42,4x2,0	42,4
4DA2323	6DA2323	42,4x2,0	48,3
-	6DA3123	48,3x2,0	33,7
-	6DA3223	48,3x2,0	42,4
-	6DA3323	48,3x2,0	48,3

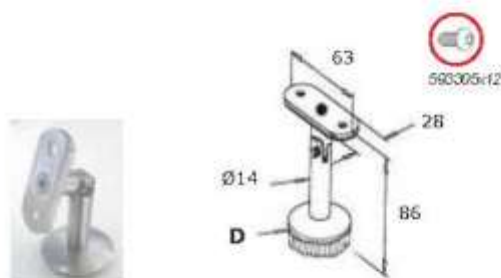

Supporto corrimano snodato "DB"

Art. Nr.		D	Ø
Aisi 304	Aisi 316		
4DB1023	6DB1023	33,7x2,0	Piatto
4DB2023	6DB2023	42,4x2,0	Piatto
-	6DB3023	48,3x2,0	Piatto

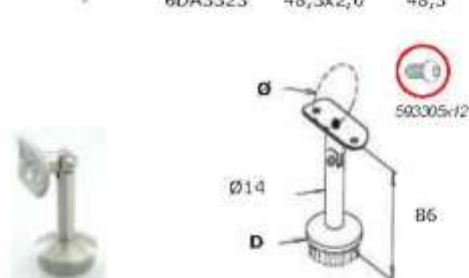

Supporto corrimano snodato "DB"

Art. Nr.		D	Ø
Aisi 304	Aisi 316		
4DB1123	6DB1123	33,7x2,0	33,7
4DB1223	6DB1223	33,7x2,0	42,4
4DB1323	6DB1323	33,7x2,0	48,3
4DB2123	6DB2123	42,4x2,0	33,7
4DB2223	6DB2223	42,4x2,0	42,4
4DB2323	6DB2323	42,4x2,0	48,3
6DB3123	6DB3223	48,3x2,0	33,7
-	6DB3323	48,3x2,0	48,3



Base supporto per perno MB

Art. Nr.		Ø
Aisi 304	Aisi 316	
D4G1	D6G1	33,7x2,0
D4G2	D6G2	42,4x2,0
-	D6G3	48,3x2,0

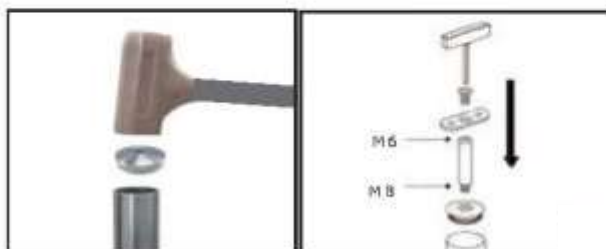

2 INOX-flex serie componibile

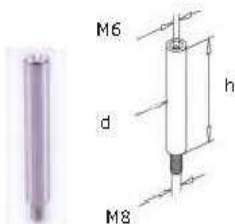

Perno diritto M8 M-F

Art. Nr.	d	h	Aisi
D4C23	14	70	304
D6C23	14	70	316

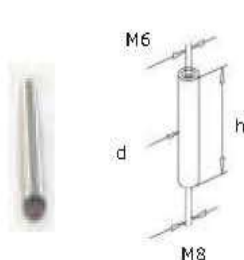

Perno diritto M8 F-F

Art. nr.	d	h	Aisi
D4B23	14	70	304
D6B23	14	70	316

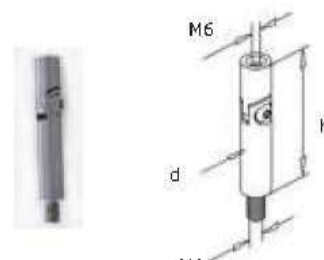

Perno snodato M8 M-F

Art. Nr.	d	h	Aisi
D4D23	14	75	304
D6D23	14	75	316

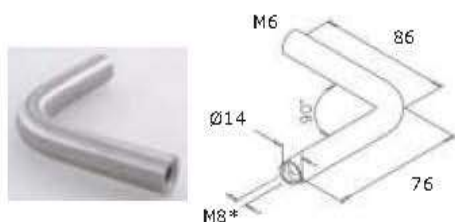

Perno curvo fisso "DE"

Art. nr.	
Aisi 304	Aisi 316
D4E4	D6E4

593308x20*

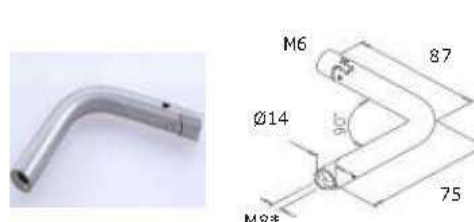

Perno curvo snodato "DF"

Art. nr.	
Aisi 304	Aisi 316
D4F4	D6F4

593308x20*

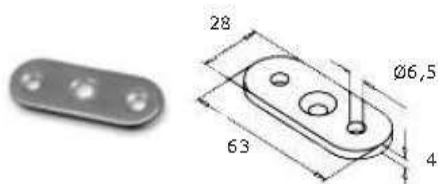

Piastrina di appoggio

Art. Nr.		Appoggio
Aisi 304	Aisi 316	
D4A021	D6A021	Piatto

593306x14

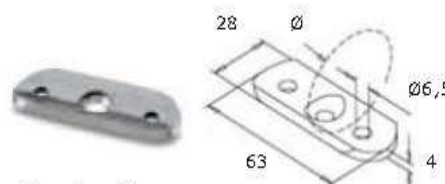

Piastrina di appoggio

Art. Nr.		Ø
Aisi 304	Aisi 316	
D4A121	D6A121	33,7
D4A221	D6A221	42,4
	D6A321	48,3

593306x14

INOX-flex serie componibile 2



Asta curva fissa "DE"(2 fori)

Art. nr.		Ø Flangia	Piastrina
Aisi 304	Aisi 316		
4DE043	6DE043	70	Piatta
4DE143	6DE143	70	Ø33,7
4DE243	6DE243	70	Ø42,4
4DE343	6DE343	70	Ø48,3



Asta curva fissa "DG"(3 fori)

Art. nr.		Ø Flangia	Piastrina
Aisi 304	Aisi 316		
4DG043	6DG043	70	Piatta
4DG143	6DG143	70	Ø33,7
4DG243	6DG243	70	Ø42,4
4DG343	6DG343	70	Ø48,3

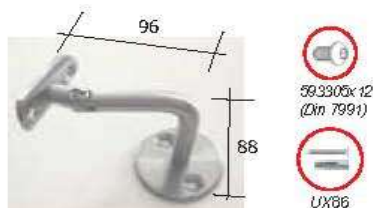

Asta curva snodata "DF"(2 fori)

Art. nr.		Ø Flangia	Piastrina
Aisi 304	Aisi 316		
4DF043	6DF043	70	Piatta
4DF143	6DF143	70	Ø33,7
4DF243	6DF243	70	Ø42,4
4DF343	6DF343	70	Ø48,3



Asta curva snodata "DH"(3 fori)

Art. nr.		Ø Flangia	Piastrina
Aisi 304	Aisi 316		
4DH043	6DH043	70	Piatta
4DH143	6DH143	70	Ø33,7
4DH243	6DH243	70	Ø42,4
4DH343	6DH343	70	Ø48,3

INOX-Flex

Gamma di articoli in acciaio inossidabile per ringhiere facilmente assemblabili con viti per creare l'articolo che necessita.

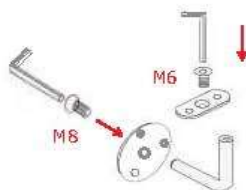

2 Raccordi di collegamento



Curva 90° M-M

Art. Nr.	Ø	H
160D33	33,7x2,0	25
160D42	42,4x2,0	30
160D48	48,3x2,0	35



Gomito 90° M-M

Art. Nr.	Ø	H
161D33	33,7x2,0	25
161D42	42,4x2,0	30
161D48	48,3x2,0	35

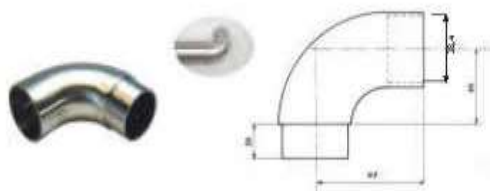

Curva 90° M-F

Art. Nr.	Ø
165	42,4x2,0



Angolo 90° M-M

Art. Nr.	Ø	H
170D33	33,7x2,0	25
170D42	42,4x2,0	30
170D48	48,3x2,0	35



Curva 90° M-F con attacco M12

Art. Nr.	Ø	H
166	42,4x2,0	44



Curva cieca 90° terminale

Art. Nr.	Ø	H
172D33	33,7x2,0	77
172D42	42,4x2,0	81
172D48	48,3x2,0	84



Curva regolabile M/M

Art. Nr.	Ø
162D42	42,4x2,0

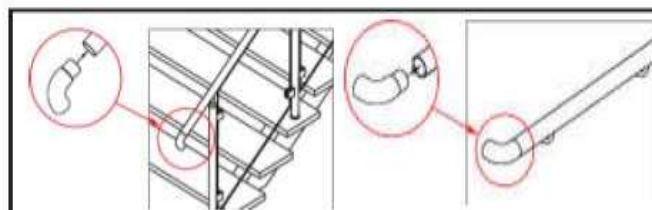

Raccordi di collegamento 2

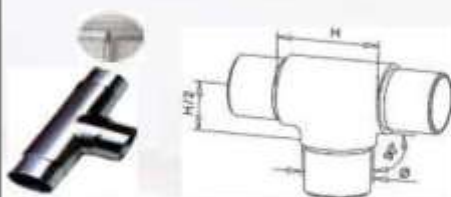

Pezzo a TEE

Art. Nr.	Ø	H
210D33	33,7x2,0	50
210D42	42,4x2,0	60
210D48	48,3x2,0	70



Gomito a tre vie

Art. Nr.	Ø	H
190D33	33,7x2,0	25
190D42	42,4x2,0	30
190D48	48,3x2,0	35



Giunto a snodo (2 vie)

Art. Nr.	Ø	H
250D33	33,7x2,0	22
250D42	42,4x2,0	28
250D48	48,3x2,0	30



Giunto a snodo (2 vie)

Art. Nr.	Ø
251	42,4x2,0



Giunto unione tubo-tubo

Art. Nr.	per tubo
290	33,7x2,0
280	42,4x2,0



Giunto di connessione tubo-tubo

Art. Nr. (Aisi304)	Art. Nr. (Aisi 316)	per tubo	A	C
-	6GA1	33,7x2,0	44	6
4GA2	6GA2	42,4x2,0	44	6
-	6GA3	48,3x2,0	44	6

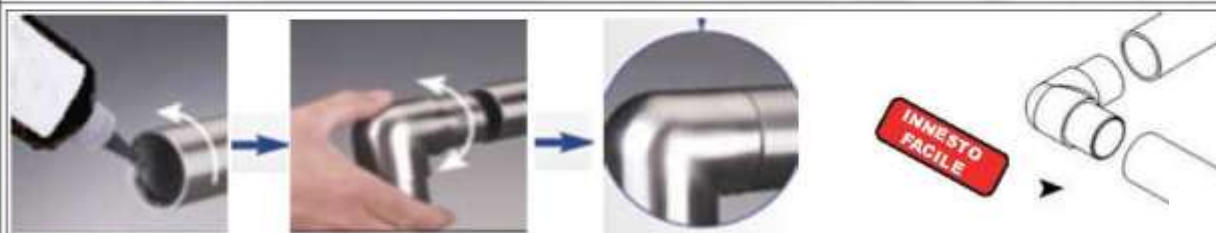

2 Tappi e calotte di chiusura



Calotta terminale piatta

Art. Nr.	Ø
141D33	33,7x2,0
141D42	42,4x2,0
141D48	48,3x2,0

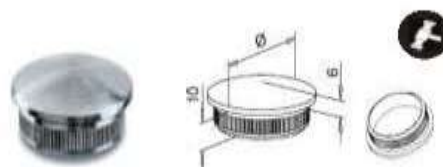

Calotta terminale piana

Art. Nr.	Ø
142D33	33,7x2,0
142D42	42,4x2,0
142D48	48,3x2,0

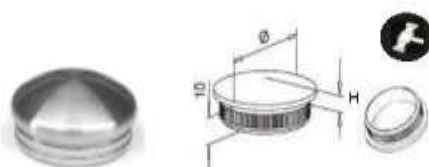

Calotta terminale semitonda

Art. Nr.	Ø	H
152D33	33,7x2,0	8,5
152D42	42,4x2,0	9

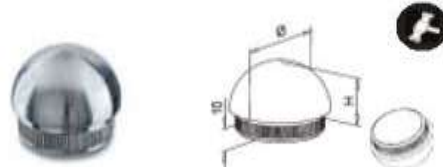

Calotta terminale semi-sferica (Dome)

Art. Nr.	Ø	H
133D33	33,7x2,0	17
133D42	42,4x2,0	21
133D48	48,3x2,0	24



Calotta terminale semitonda

Art. Nr.	Ø	H
156D33	33,7x2,0	8
156D42	42,4x2,0	9
156D48	48,3x2,0	10
156D60	60,3x2,0	11



Calotta terminale semitonda Pvc-Inox

Art. Nr.	Ø	H
130D33	33,7x2,0	8
130D42	42,4x2,0	9



ISTRUZIONI APPLICAZIONE

Veloce messa in opera con semplici ma decisi colpi con martello di gomma.
Una volta in sede garantiscono una perfetta tenuta a prova di asportazione.
Attenzione: Lo spessore del tubo deve essere di 2mm.





3 ACCESSORI PER TONDO



- SOSTEGNI PER CORRENTI
- SNODI DI COLLEGAMENTO
- CALOTTE TERMINALI

Sistema di realizzazione correnti:

TONDO Ø10mm-Ø12mm
TUBETTO Ø12mmx1,5mm

Secondo la **legislazione italiana**, attualmente in vigore, negli spazi pubblici e/o esercizi pubblici la direttiva da seguire nella realizzazione di parapetti e ringhiere con linee parallele al corrimano è quella di infittire le linee dei correnti arrivando ad una luce max di 10 cm (vedi Pag.22).

VITERIA INCLUSA !!!

I sostegni laterali (Pag.30) vengono forniti comprensivi di viteria di fissaggio

3 Sostegni laterali

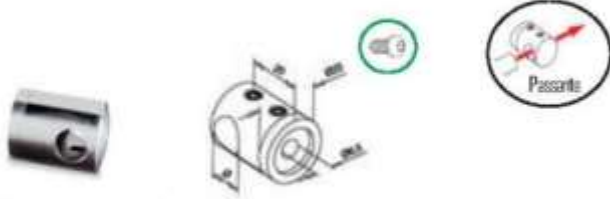

Sostegno per tondo

Art. Nr.	Ø	D
313F	10	PIATTO
312F	12	PIATTO

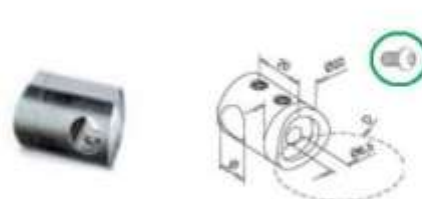

Sostegno per tondo

Art. Nr.	Ø	D
313D33	10	Ø33,7
313D42	10	Ø42,4
312D33	12	Ø33,7
312D42	12	Ø42,4
312D48	12	Ø48,3



Sostegno cieco sinistro per tondo

Art. Nr.	Ø	D
312FSX	12	PIATTO



Sostegno cieco sinistro per tondo

Art. Nr.	Ø	D
312D33SX	12	Ø33,7
312D42SX	12	Ø42,4
312D48SX	12	Ø48,3



Sostegno cieco destro per tondo

Art. Nr.	Ø	D
312FDX	12	PIATTO



Sostegno cieco destro per tondo

Art. Nr.	Ø	D
312D33DX	12	Ø33,7
312D42DX	12	Ø42,4
312D48DX	12	Ø48,3

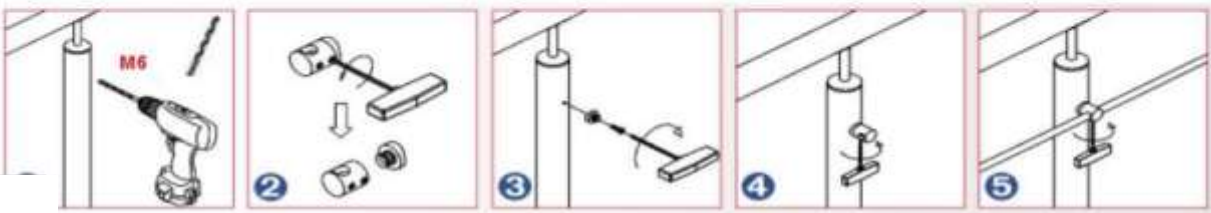

Sostegni laterali e centrali, snodi e terminali per correnti

3



Sostegno per tondo con vite passante

Art. Nr.	Ø	D
311	12	Ø42,4

fino a esaurimento scorte

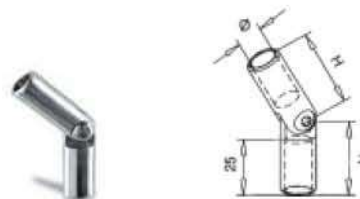

Giunzione a snodo (+90°/-90°)

Art. Nr.	Ø	H
319	10 mm	35
318	12 mm	36



Sostegno centrale fisso per tondo

Art. Nr.	Ø	A	B	C
315F/12	PIATTO	12	Ø22	35
315D42/12	42,4	12	Ø22	35

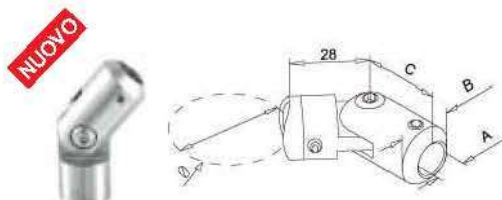

Sostegno centrale snodato per tondo ± 90°

Art. nr.	Ø	A	B	C
309F/12	PIATTO	12	Ø22	30
309D42/12	42,4	12	Ø22	30

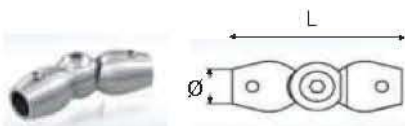

Giunzione snodata per tondo (±90°)

Art. Nr.	Ø	L
350	12	68

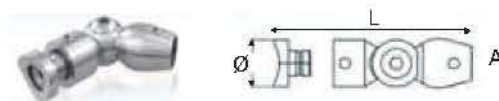

Attacco centrale snodato(+90°/-90°)

Art. Nr.	Ø	A	L
340	42,4	12	66

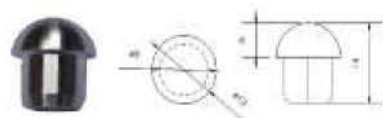

Tappo terminale semi-sferico

Art. Nr.	Ø	H
154	12,0x1,5	6

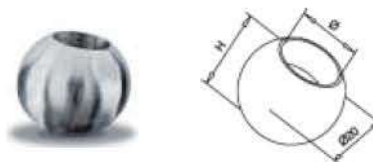

Tappo terminale sferico

Art. Nr.	Ø	H
317	10	18,5
316	12	17,5





4 TUBI E BARRE INOX



Tubi e Tondi calibrati con tolleranze ristrette per consentire un preciso e rapido innesto ai raccordi di collegamento.

I tubi e tondi qui in dettaglio presentano il medesimo trattamento di satinatura della superficie:

SATINATURA GRANA 320 "SCOTCH BRITE"

Questa satinatura è la stessa presente in tutti gli accessori e raccordi in questo catalogo. Questo al fine di garantire una continuità estetica tra tubo e accessori.

SERVIZIO DI TAGLIO TUBO

Si effettuano tagli delle barre nelle misure richieste



Finitura Inox

Satinato Grana 320
"Scotch Brite"



Barra filettata [L=1000 mm]

Art. Nr.	Ø	Aisi
Barra M3	M3	304
Barra M4	M4	304
Barra M5	M5	304
Barra M6	M6	304
Barra M8	M8	304
Barra M10	M10	304
Barra M12	M12	304
Barra M14	M14	304
Barra M16	M16	304



Tondo pieno Ø10mm [L=3000 mm]

Art. Nr.	Ø	Aisi
TR10304	10 mm	304
TR10316	10 mm	316



Tondo pieno Ø12mm [L=3000 mm]

Art. Nr.	Ø	Aisi
TR12304	12 mm	304
TR12316	12 mm	316



Tubo - Ø12mm [L=6000 mm]

Art. Nr.	Ø	S	Aisi
TUS012S15S	12 mm	1,5 mm	304



Tubo - Ø33,7mm [L=6000 mm]

Art. Nr.	Ø	S	Aisi
TUS033S20S	Ø33,7	2,0 mm	304
TUS033S206S	Ø33,7	2,0 mm	316



Tubo - Ø42,4mm [L=6000 mm]

Art. Nr.	Ø	S	Aisi
TUS042S20S	Ø42,4	2,0 mm	304
TUS042S206S	Ø42,4	2,0 mm	316



Tubo - Ø48,3mm [L=6000 mm]

Art. Nr.	Ø	S	Aisi
TUS048S20S	Ø48,3	2,0 mm	304
TUS048S206S	Ø48,3	2,0 mm	316



Tubo - Ø42,4 mm Forato [L=6000 mm]

Art. Nr.	Ø	S	Aisi
1070	Ø42,4	2 mm	304



5

INOX-Legno



"...il calore del legno abbinato alla modernità dell'acciaio inox..."

La gamma si arricchisce del nuovo sistema inox per legno: **INOX-Legno**.

Inox al servizio della natura in abbinamento a corrimani in legno (color noce naturale).

I corrimani in legno sono semplici e veloci da posare attraverso l'uso di passpartout che vengono fissati al legno con viti e al giunto inox tramite incollaggio con l'adesivo per inox Art.320 (vedi pag.52)

ESSENZA
NOCE NATURALE





Barra tonda in legno (Noce naturale)

Art. Nr.	∅	L (mm)
TUS042SW	42,4	2600

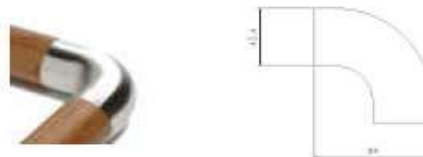

Curva 90°

Art. Nr.	∅	imballo/pz
160D42W	42,4	1



Tappo terminale piatto

Art. Nr.	∅	imballo/pz
141D42W	42,4	1

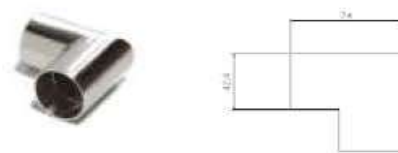

Angolo 90°

Art. Nr.	∅	imballo/pz
170D42W	42,4	1

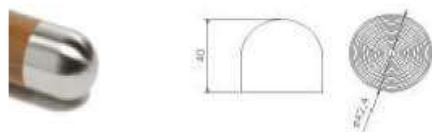

Tappo terminale "Dome"

Art. Nr.	∅	imballo/pz
133D42W	42,4	1



Giunto a snodo ±90°

Art. Nr.	∅	imballo/pz
250D42W	42,4	1

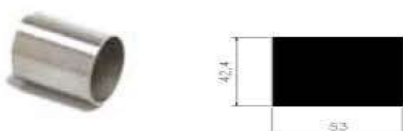

Giunto di connessione

Art. Nr.	∅ tubi	imballo/pz
280D42W	42,4	1



Passpartout di connessione

Art. Nr.	∅ per tubo	∅42,4	imballo/pz
281D42W	38,2	∅42,4	1



Kit connessione

Art. Nr.	∅ tubi	Composizione	imballo/pz
282D42W	42,4	280D42W + 281D42W (x2pz)	1





6 SISTEMA CAVO INOX

TIRANTI COMPLETI ACCESSORI SINGOLI VARI

Questi accessori permettono di "tirare" un cavo ($\varnothing 4 \text{ mm} - \varnothing 6 \text{ mm}$) senza l'ausilio di attrezzi speciali.

Si possono seguire percorsi orizzontali con tiranti fissi o orizzontali e inclinati con tiranti snodati.

ACCORGIMENTI DA SEGUIRE:

Interporre i montanti in modo da avere una luce utile massima di 1,80 mt - 2,00 mt del cavo. Misure superiori possono portare ad una perdita di tensione e rilascio del cavo stesso.

Il cavo può passare attraverso i montanti ma va fermato con il tirante ogni 4/6 mt.

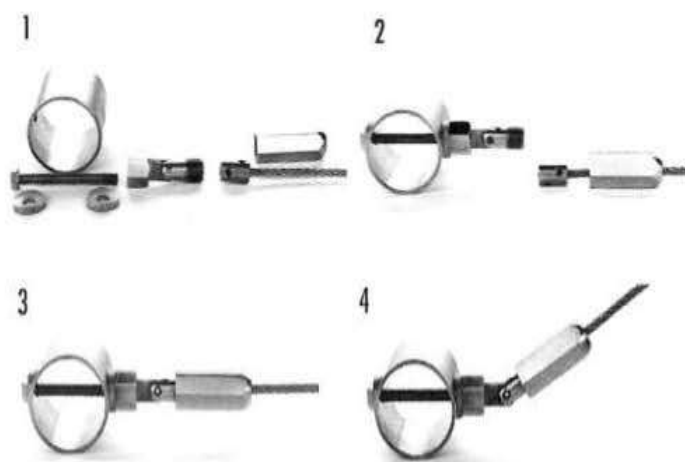

Tiranti di fissaggio cavo 6

Ø4 mm
Ø6 mm



Tirante FISSO completo

Art. Nr.	Ø cavo	utilizzo
475	4 mm	percorsi orizzontali in asse
485	6 mm	

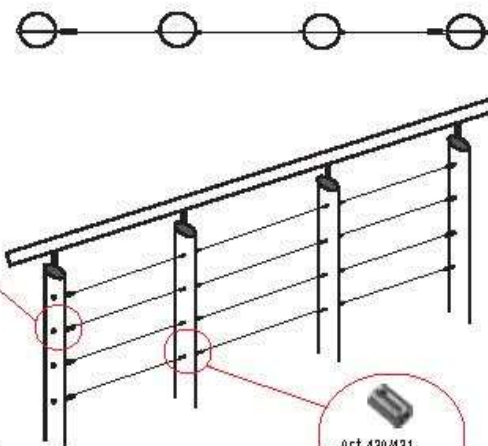

Tirante SNODATO completo

Art. Nr.	Ø cavo	utilizzo
470	4 mm	percorsi inclinati e misti in asse o fuori asse
480	6 mm	

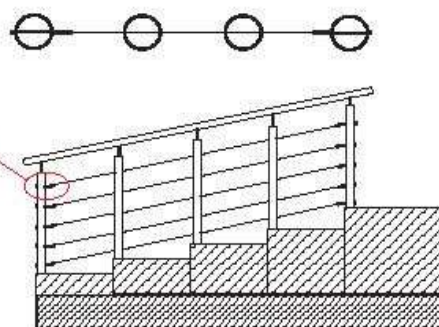

Gancio passante completo

Art. Nr.	Ø cavo	Utilizzo
435	4 mm	Linea guida per cavo tra due tiranti d'estremità (Art. 470) nelle applicazioni fuori asse

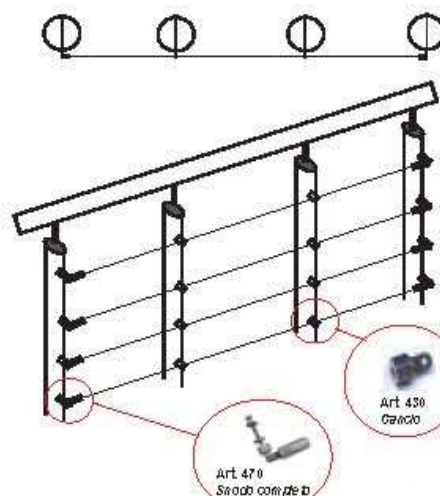

6 Cavo inox e accessori



CAVO ACCIAIO INOX 7X7 Aisi 316			
Art. No.	Ø Cavo	Resistenza a Trazione (Kn)	Peso (Kg/100mt)
490	4mm	9,5	7,0
492	6mm	21,4	14,8

Cavo acciaio inox (7x7) Aisi 316

Art. Nr.	Ø	Bobine
490	4 mm	100mt
492	6 mm	100mt

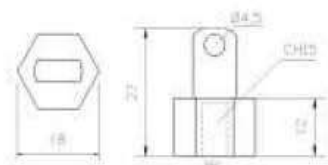

Gancio passante per cavo

Art. Nr.	Ø cavo	F	Conf.
430	4 mm	M6	2 pz

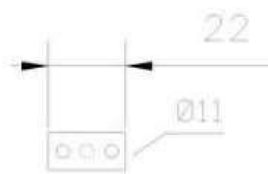

Morsetto serracavo

Art. Nr.	Ø cavo	Grani serraggio	Conf.
420	4 mm	×3	10 pz
421	6 mm	×3	10 pz

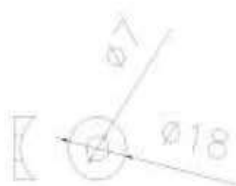

Rondella per vite M6 su tubo

Art. Nr.	Ø tubo	Utilizzo	Conf.
440	42,4	Adattatore in appoggio per tubo	4 pz

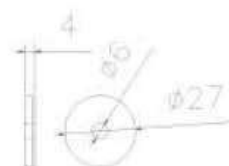

Rondella per vite M6 su muro

Art. Nr.	Utilizzo	Conf.
441	Con set tenditori cavo inox in appoggio su superfici piatte (muro, soffitto, parete,...).	4 pz

CAVOPASSANTE

Interasse massimo per tenditore L=6000mm. Ciò vuol dire che il cavo inox può passare attraverso i montanti opportunamente forati ma, ogni L=6000mm max, deve essere chiuso da un tenditore (fisso/snodato) in modo da mantenere la tensione al cavo che altrimenti si perderebbe.



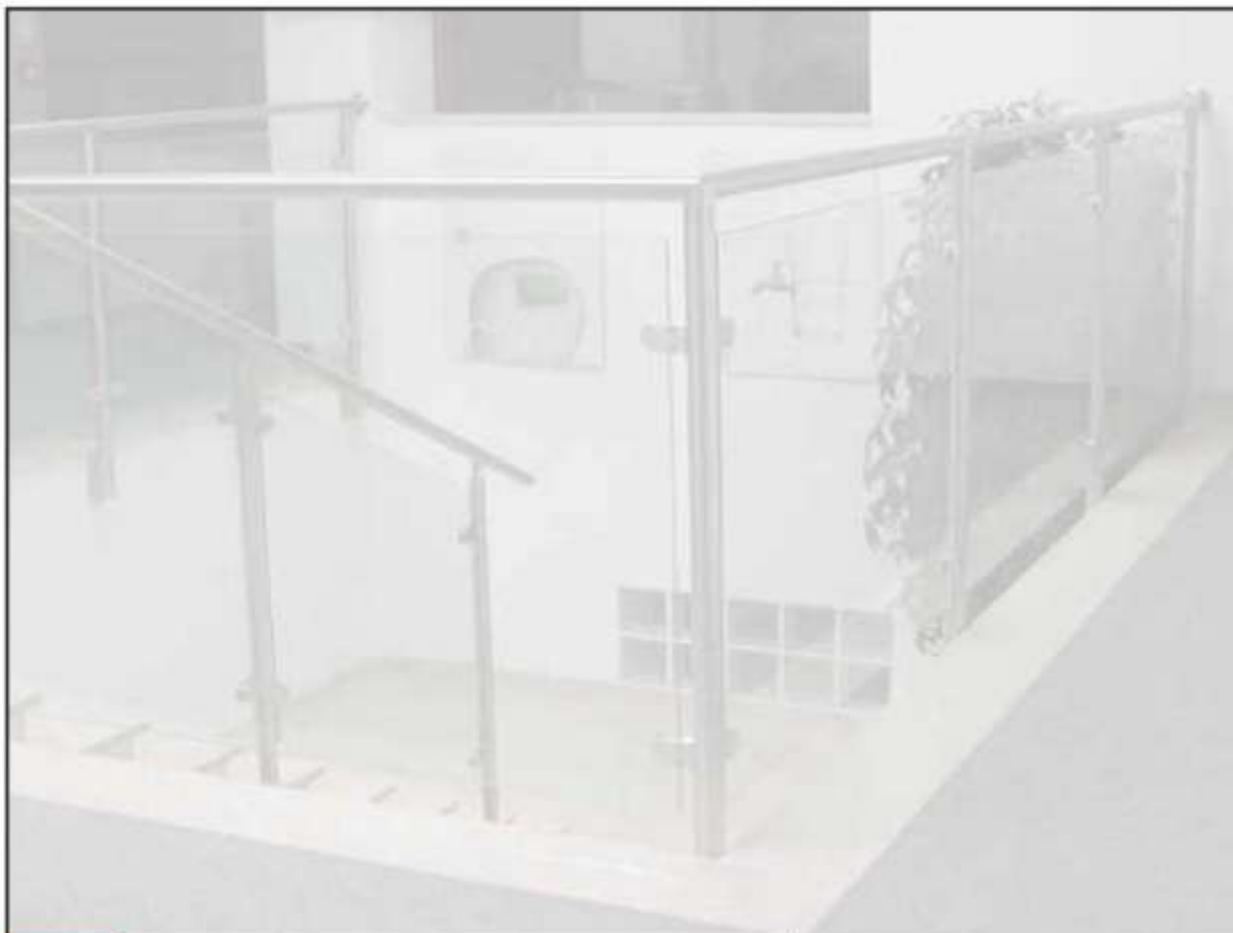

7

SISTEMA VETRO CON MORSETTI E SOSTEGNI

MORSETTI FISSAGGIO VETRO SOSTEGNI FRONTALI VETRO SOSTEGNI PER LAMIERA

Elementi professionali in Acciaio Inox e Zama per il fissaggio del vetro e lamiera (Art.310 pag.44) ai montanti. Il fissaggio di questi elementi viene effettuato tramite avvitamento dopo aver forato e filettato il montante.

DESIGN e SICUREZZA vengono così garantiti ed esaltati dall'utilizzo di tali elementi combinati con lastre di vetro monolitico, temprato o stratificato (laminato).

A tutti gli elementi costruttivi in Acciaio inox (Aisi 316) e Zama vengono abbinati profili sagomati in gomma EPDM per garantire un ottimale e sicuro contatto con il vetro.

I serravetro qui dettagliati vengono tutti forniti comprensivi di viteria di fissaggio, copriviti in plastica e PERNI DI SICUREZZA.



7 SICUREZZA: Test internazionali

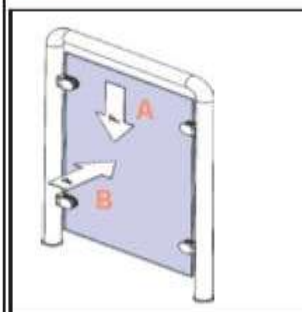

FORZA VERTICALE

Massima forza verticale ammessa (senza pemo di sicurezza) per n. 4 serravetro
(Normativa TUV)

A = 100 KG

FORZA ORIZZONTALE

Massima forza orizzontale ammessa per n. 4 serravetro

B = 300 KG

TUV

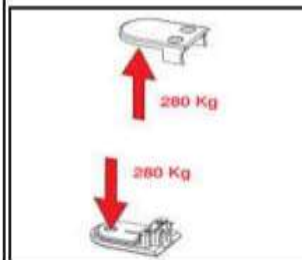

KG 280 è la forza minima orizzontale a cui i serravetro devono resistere.
(Normativa ETB)

ETB

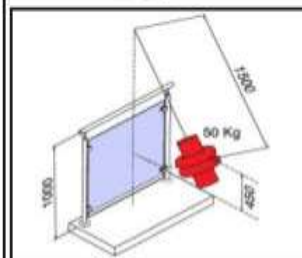

Entro le dimensioni riportate in tabella l'insieme pannello-serravetro (Acciaio inossidabile e/o Zama) è concepito per resistere alla proiezione di un sacco da 50 Kg. Questo per simulare la caduta di una persona, caduta che deve essere arrestata dall'insieme pannello-serravetro senza cedere per sfondamento.

(Normativa EN 12600)

DIN/EN 12600

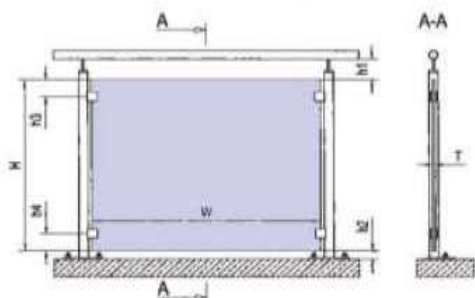

DIMENSIONI (mm)		Min.	Max.
W	lunghezza pannello	500	vedi tabella
T	spessore del vetro	vedi tabella	vedi tabella
H	altezza pannello	800	1000
h ₁	alt. corniario-pannello	10	50
h ₂	altezza suolo - vetro	10	50
h ₃	altezza serravetro sup.	100	150
h ₄	altezza serravetro inf.	100	150

SICUREZZA: Risultati Test DIN/EN 12600

Aisi 316 Zama	Base Piatta	per Tubo	Ø tubo	Tipo di Vetro	W (mm)	T (mm)
MOD. 260 - 270			33,7 42,4	VSG/TVG	500-1500	6,76/9,76/9,52
				VSG/ESG	500-1500	8,76/9,52
				Mono/ESG-H	500-1500	8/8/10
MOD. 262 - 272			42,4	VSG/TVG	500-1500	10,76/12,76/11,52
				VSG/ESG	500-1500	10,76/11,52/12,76
				Mono/ESG-H	500-1800 500-1500	8/10/12
MOD. 263-273			48,3	VSG/SPG	500-1500	9,52/11,52/12,76/16,76/13,52/17,52
				VSG/TVG	500-1500	9,52/11,52/12,76/16,76/13,52/17,52
				VSG/ESG	500-1500	9,52/11,52/12,76/16,76/13,52/17,52
				Mono	500-1800	12/15

VSG: Vetro laminato TVG: Vetro temprato termico ESG: Vetro temprato ESG-H: Vetro temprato testato al calore Mono: Vetro monolitico

Serravetro MOD. 260/270 per spessori del vetro 6mm-10mm

7

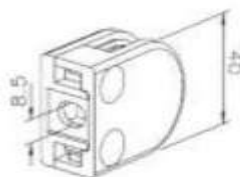
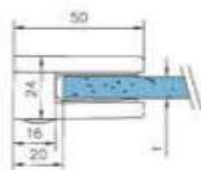

PIATTO

Modello 260F

Acciaio Inox Aisi 316

Art. Nr.	T Spessore vetro (mm)
260FG6	6
260FG676	6,76
260FG8	8
260FG876	8,76
260FG952	9,52
260FG10	10

Modello 270F

Zama finitura inox

Art. Nr.	T Spessore vetro (mm)
270FG6	6
270FG676	6,76
270FG8	8
270FG876	8,76
270FG952	9,52
270FG10	10

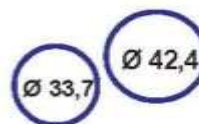
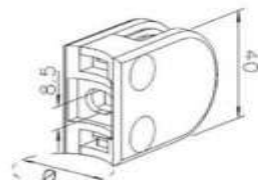
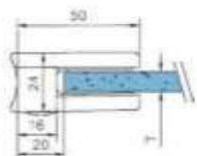

Modello 260D

Acciaio Inox Aisi 316

Art. Nr.	Ø	T Spessore vetro (mm)
260D33G6	33,7	6
260D33G676	33,7	6,76
260D33G8	33,7	8
260D33G876	33,7	8,76
260D33G952	33,7	9,52
260D33G10	33,7	10
260D42G6	42,4	6
260D42G676	42,4	6,76
260D42G8	42,4	8
260D42G876	42,4	8,76
260D42G952	42,4	9,52
260D42G10	42,4	10

Modello 270D

Zama finitura inox

Art. Nr.	Ø	T Spessore vetro (mm)
270D33G6	33,7	6
270D33G676	33,7	6,76
270D33G8	33,7	8
270D33G876	33,7	8,76
270D33G952	33,7	9,52
270D33G10	33,7	10
270D42G6	42,4	6
270D42G676	42,4	6,76
270D42G8	42,4	8
270D42G876	42,4	8,76
270D42G952	42,4	9,52
270D42G10	42,4	10

Fig.3 Fasi di montaggio dei Serravetro tramite mascheratura M8 del tubo dopo averlo forato con punta Diam. 8,8. Si consiglia l'utilizzo dell'inserto M8 che si applica al tubo con appositi utensili dopo averlo forato con punta corrispondente. La nostra preparazione del tubo prevede la foratura per fusione e la successiva rullatura M8.



Chiave di lettura Codici SERRAVETRO

modello Inox	260	D42	G8	spessore del vetro
modello Zama	270	F		
		D=diametro tubo	F= flat (piatto)	

7 Serravetro MOD.262/272 per spessori del vetro 8mm-12,76mm

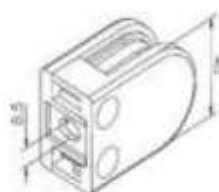
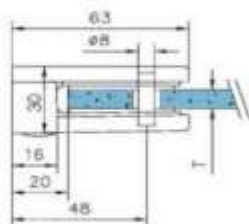

PIATTO

Modello 262F

Acciaio Inox Aisi 316

Art. Nr.	T Spessore vetro (mm)
262FG8	8
262FG876	8,76
262FG952	9,52
262FG10	10
262FG1076	10,76
262FG1152	11,52
262FG12	12
262FG1276	12,76

Modello 272F

Zama finitura inox

Art. Nr.	T Spessore vetro (mm)
272FG8	8
272FG876	8,76
272FG952	9,52
272FG10	10
272FG1076	10,76
272FG1152	11,52
272FG12	12
272FG1276	12,76

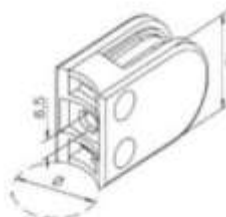
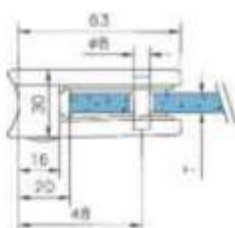

Ø 42,4

Modello 262D

Acciaio Inox Aisi 316

Art. Nr.	Ø	T Spessore vetro (mm)
262D42G8	42,4	8
262D42G876	42,4	8,76
262D42G952	42,4	9,52
262D42G10	42,4	10
262D42G1076	42,4	10,76
262D42G1152	42,4	11,52
262D42G12	42,4	12
262D42G1276	42,4	12,76

Modello 272D

Zama finitura inox

Art. Nr.	Ø	T Spessore vetro (mm)
272D42G8	42,4	8
272D42G876	42,4	8,76
272D42G952	42,4	9,52
272D42G10	42,4	10
272D42G1076	42,4	10,76
272D42G1152	42,4	11,52
272D42G12	42,4	12
272D42G1276	42,4	12,76

ACCESSORI inclusi nelle confezioni



Set di Gomme (EPDM) dello spessore indicato

Perno di sicurezza



Vite M6 di chiusura

Copriviti di chiusura in plastica



Vite M6 fissaggio serravetro

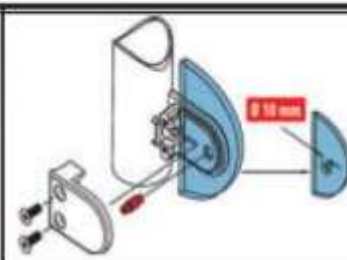

Serravetro MOD.263/273 per spessori del vetro 9,52mm-17,52mm

7

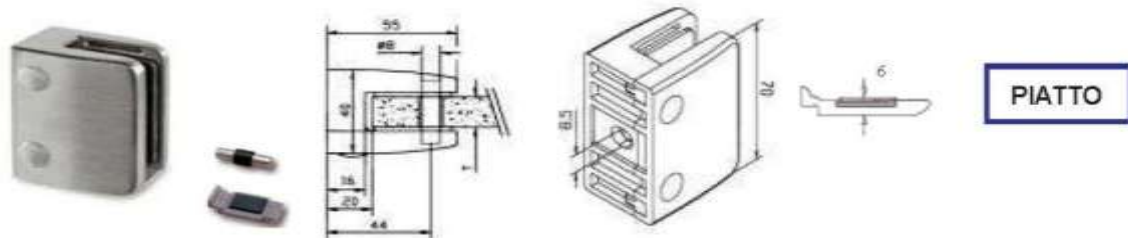

Modello 263F

Acciaio Inox Aisi 316

Art. Nr.	T Spessore vetro (mm)
263FG952	9,52
263FG1152	11,52
263FG12	12
263FG1276	12,76
263FG1352	13,52
263FG15	15
263FG1676	16,76
263FG1752	17,52

Modello 273F

Zama finitura inox

Art. Nr.	T Spessore vetro (mm)
273FG952	9,52
273FG1152	11,52
273FG12	12
273FG1276	12,76
273FG1352	13,52
273FG15	15
273FG1676	16,76
273FG1752	17,52

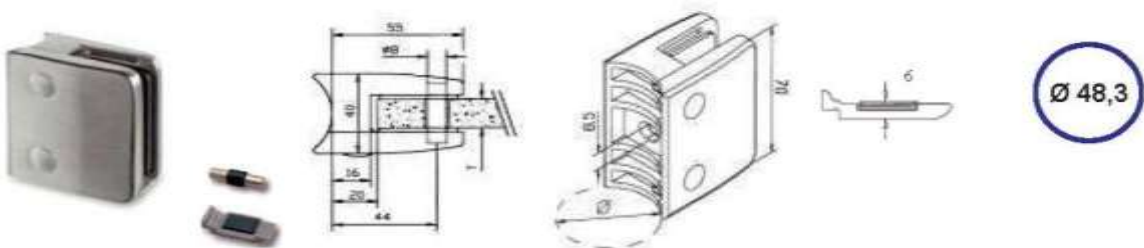

Modello 263D48

Acciaio inox Aisi 316

Art. Nr.	T Spessore vetro (mm)
263D48G952	9,52
263D48G1152	11,52
263D48G12	12
263D48G1276	12,76
263D48G1352	13,52
263D48G15	15
263D48G1676	16,76
263D48G1752	17,52

Modello 273D48

Zama finitura inox

Art. Nr.	T Spessore vetro (mm)
273D48G952	9,52
273D48G1152	11,52
273D48G12	12
273D48G1276	12,76
273D48G1352	13,52
273D48G15	15
273D48G1676	16,76
273D48G1752	17,52

TIPOLOGIE DI VETRO E SPESSORI

MONO	LAM												
6 - 8 - 10 - 12 - 15 mm	<table border="0"> <tr> <td>6,76 mm (3 - 0,76 - 3)</td> <td>13,52 mm (6 - 1,52 - 6)</td> </tr> <tr> <td>8,76 mm (4 - 0,76 - 4)</td> <td>16,76 mm (8 - 0,76 - 8)</td> </tr> <tr> <td>9,52 mm (4 - 1,52 - 4)</td> <td>17,52 mm (8 - 1,52 - 8)</td> </tr> <tr> <td>10,76 mm (5 - 0,76 - 5)</td> <td></td> </tr> <tr> <td>11,52 mm (5 - 1,52 - 5)</td> <td></td> </tr> <tr> <td>12,76 mm (6 - 0,76 - 6)</td> <td></td> </tr> </table>	6,76 mm (3 - 0,76 - 3)	13,52 mm (6 - 1,52 - 6)	8,76 mm (4 - 0,76 - 4)	16,76 mm (8 - 0,76 - 8)	9,52 mm (4 - 1,52 - 4)	17,52 mm (8 - 1,52 - 8)	10,76 mm (5 - 0,76 - 5)		11,52 mm (5 - 1,52 - 5)		12,76 mm (6 - 0,76 - 6)	
6,76 mm (3 - 0,76 - 3)	13,52 mm (6 - 1,52 - 6)												
8,76 mm (4 - 0,76 - 4)	16,76 mm (8 - 0,76 - 8)												
9,52 mm (4 - 1,52 - 4)	17,52 mm (8 - 1,52 - 8)												
10,76 mm (5 - 0,76 - 5)													
11,52 mm (5 - 1,52 - 5)													
12,76 mm (6 - 0,76 - 6)													



7a Accessori fissaggio vetro e lamiera

ACCIAIO INOX Aisi 316

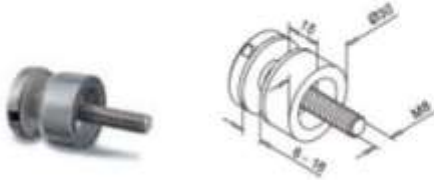

Sostegni frontali per vetro

Art. Nr.	Spessore Vetro (mm)
268F	6-16



Sostegni frontali per vetro

Art. Nr.	per tubo	Spessore Vetro (mm)
268D33	Ø33,7	6-16
268D42	Ø42,4	6-16

ZAMA "Finitura inox"



Sostegni frontali per vetro

Art. Nr.	Spessore Vetro (mm)
278F	6-16



Sostegni frontali per vetro

Art. Nr.	per tubo	Spessore Vetro (mm)
278D33	Ø33,7	6-16
278D42	Ø42,4	6-16

ACCIAIO INOX Aisi 304

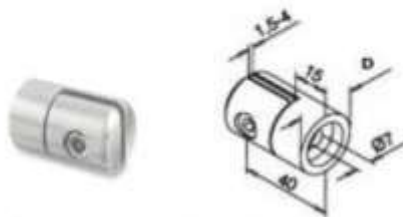

Sostegno per lamiera D25

Art. nr.	Ø
310F	Piatto

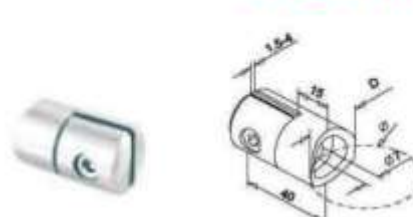

Sostegno per lamiera D25

Art. nr.	Ø
310D33	33,7
310D42	42,4
310D48	48,3

SOSTEGNO PER LAMIERA E PANNELLI MAX 4mm

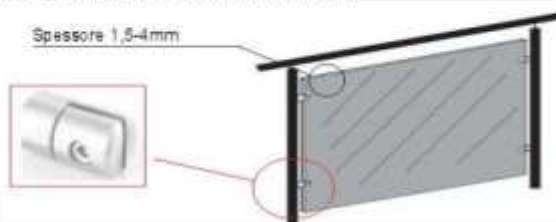

SOSTEGNI FRONTALI VETRO E PLEXIGLASS MAX. 16mm

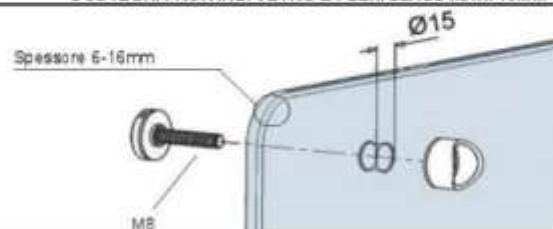



8

SISTEMA VETRO CON TUBO SCANALATO

**- RACCORDI PER TUBO SCANALATO
- TUBOLARE E GUARNIZIONE IN GOMMA**

Sistema di chiusura con Profilo scanalato a U per parapetti con vetro di grosso spessore, fino a 22mm, richiesto principalmente in strutture pubbliche ed esercizi commerciali.

Il risultato sarà di notevole impatto estetico, senza rinunciare alla praticità, all'efficienza e alla resistenza.

Giunzione elementi per incollaggio con adesivo apposito per acciaio Art. 320 (pag.52).



8 **Raccordi per tubo scanalato**



Gomito 90° scanalato (Orizz.)

Art. Nr.	Ø	H
173D42	42,4x1,5	30

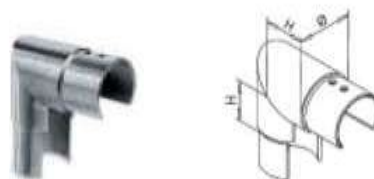

Gomito 90° scanalato (Vert.)

Art. Nr.	Ø	H
174D42	42,4x1,5	30



Giunto scanalato

Art. Nr.	Ø
285D42	42,4x1,5



Sella scanalata

Art. Nr.	Ø	D
159D42	42,4	42,4x1,5



Calotta scanalata

Art. Nr.	Ø
158D42	42,4x1,5

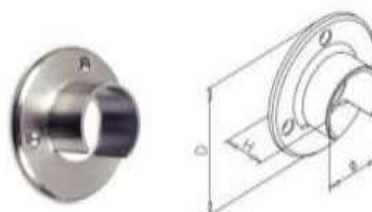

Piastra murale scanalata

Art. Nr.	Ø	D	H
175D42	42,4	90	30

Tubolare e guarnizione in gomma EPDM 8



Tubo Scanalato - Profilo U

Art.Nr.	Ø	U	T	L
TU04224SC	42,4x1,5	24	24	6000 mm

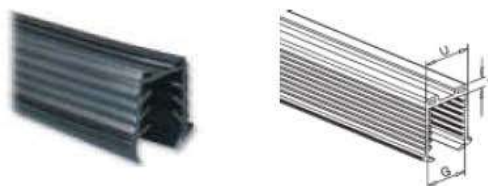

Guarnizione in caucciù per tubo scanalato

Art. Nr.	Ø	U	G	L
GOMMA813	42,4	24	8-13mm	su misura
GOMMA1418	42,4	24	14-18mm	su misura
GOMMA2022	42,4	24	20-22mm	su misura

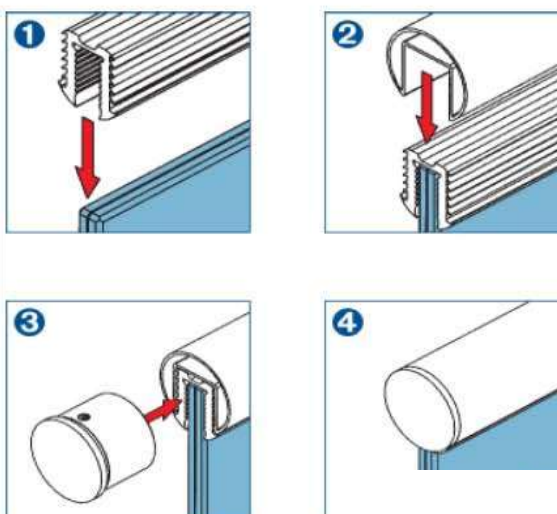
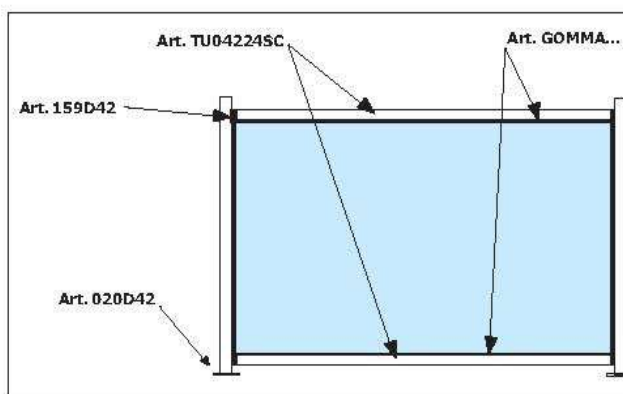

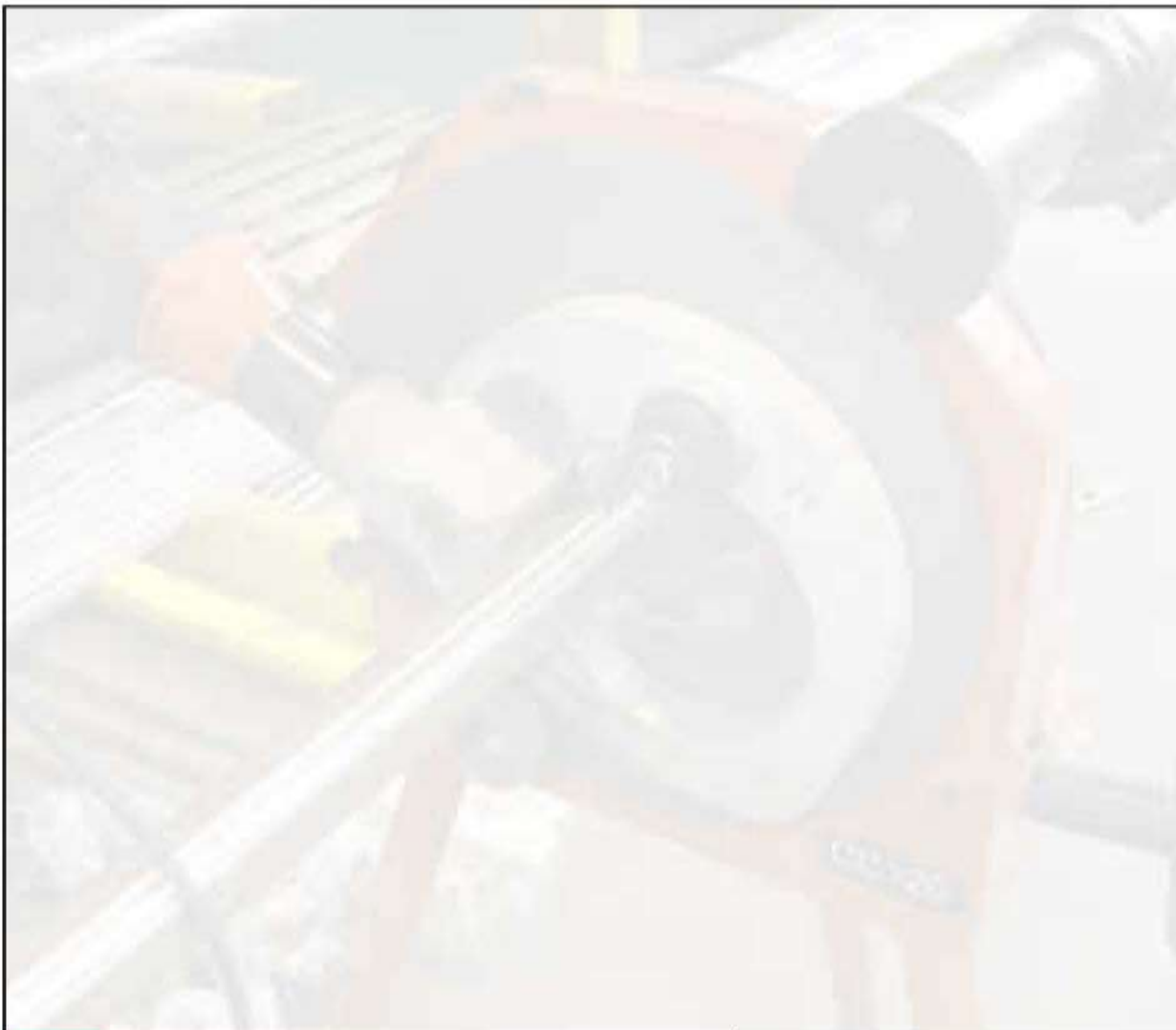

9

USO E MANUTENZIONE INOX



ADESIVI E SPRAY MANTENIMENTO ACCESSORI E ELEMENTI DECORATIVI VITERIA

Accessoristica generale per giuntare e fissare la gamma di prodotti illustrata in questo catalogo.

Consigliamo sempre di utilizzare anche nella viteria l'acciaio inox in modo da preservare le componenti nel miglior modo possibile.

La viteria in alcuni casi è fornita insieme all'articolo e in altri è da specificare al momento dell'ordine.

Uso e manutenzione inox 9

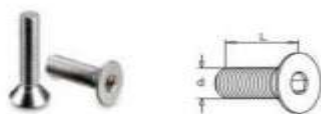

Vite testa svasata cava esag. 5933 A2

Art. nr.	d	L
593305x12	M5	12
593305x16	M5	16
593305x20	M5	20
593305x25	M5	25
593306x10	M6	10
593306x12	M6	12
593306x14	M6	14
593306x16	M6	16
593306x20	M6	20
593306x25	M6	25
593308x14	M8	14
593308x20	M8	20
593308x25	M8	25
593308x30	M8	30

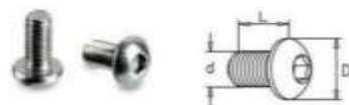

Vite testa bombata esag. incassato ISO7380 A2

Art. nr.	d	L
738005x10	M5	10
738005x16	M5	16



Viti autofilettanti per legno DIN7981

Art. nr.	d	L
798105x16	4,8	20
798105x19	4,8	23
798105x25	4,8	29
798105x38	4,8	42



Vite T. cilind. cava esag. 5931 A2

Art. nr.	d	L
593106x10	M6	10
593106x16	M6	16
593106x20	M6	20
593106x25	M6	25
593108x16	M8	16
593108x20	M8	20
593108x25	M8	25
593108x30	M8	30



Dado esagonale cieco UNI 572-69 A2

Art. nr.	E	B	C	M
572106	M6	12	4,5	10
572108	M8	15	6,0	13
572110	M10	18	7,0	17
572112	M12	22	9,4	19
572114	M14	25	11	22
572116	M16	27,5	11,5	24
572118	M18	32,5	15	27
572120	M20	34,5	15,5	30



Vite inox testa esagonale

Art. Nr.	E	A
450	M6	60



Vite inox "tutto filetto"

Art. Nr.	E	A
451	M6	63

9 Accessori uso e manutenzione

ANCORANTI UNIVERSALI

Lt lunghezza tassello (mm)
 Øf diametro punta (mm)
 P profondità minima del foro (mm)
 Sp spessore min. supporto (mm)
 S spessore max. fissabile (mm)
 Øv diametro vite (mm)
 Lv lunghezza vite (mm)

**GARANZIA
 NYLON
 GARANTITE**

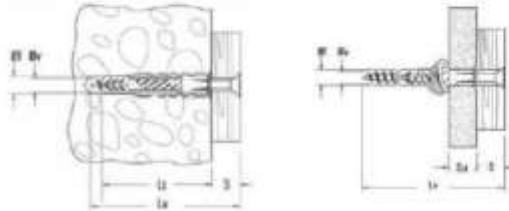

Tassello universale in nylon con vite inox

Art. nr.	ØfxLt	P	S	ØvxLv	pz/imballo
UX85	8x50	60	10	5x60	30
UX86	8x50	60	10	6x60	30

ANCORANTI MECCANICI

Lt lunghezza ancorante (mm)
 Øf diametro punta (mm)
 P profondità minima del foro (mm)
 hv profondità min. ancoraggio (mm)
 S spessore max. fissabile (mm)
 Øv diametro vite (mm)
 Ch chiave



Vite autofilettante zincata

Art. nr.	ØfxP	Øv	hv	S	pz/imballo
TA10080	8x90	10	65	10	10
TA10100	8x110	10	70	20	10
TA10120	8x130	10	75	30	10

NOTABENE:

S = Spessore Flangia + eventuale rivestimento + eventuale spessore del materiale di riempimento

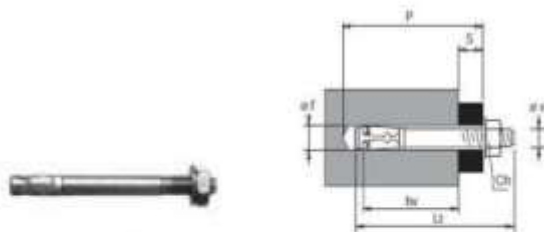

Tassello acciaio inox (8x75)

Art. nr.	ØfxLt	P	hv	S	Øv	ch	pz/imballo
T18	8x75	75	45	10	8	13	3

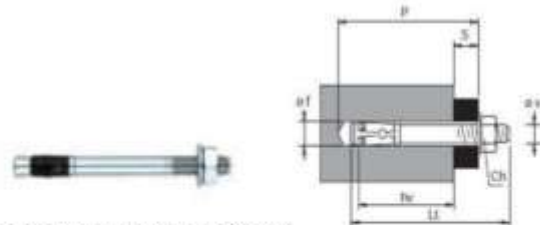

Tassello acciaio zincato (8x77)

Art. nr.	ØfxLt	P	hv	S	Øv	ch	pz/imballo
T28	8x77	75	45	10	8	13	3

ANCORANTI CHIMICI



indoor

outdoor

idoneo per tutti i tipi di supporto anche a contatto continuativo con acqua



indoor

Usare preferibilmente per interni (non idoneo per applicazioni a contatto con acqua e/o umidità)

Ancorante chimico con 2 miscelatori

Art. nr.	contenuto	pz/imballo
AC1	300ml	1

Ancorante chimico con 2 miscelatori

Art. nr.	contenuto	pz/imballo
AC2	300ml	1

$\varnothing f$ diametro punta (mm)
 P profondità minima del foro (mm)
 hs profondità inserimento (mm)
 $\varnothing b$ filettatura (mm)

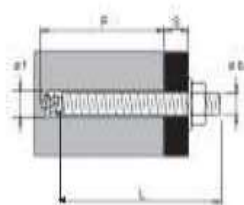

Barretta con rondella e dado - dado cieco

Art. BA	Art. BAC	$\varnothing f$	$\varnothing b$	L	pz/imballo
BA695	BAC695	8	M6	95	10
BA898	BAC898	10	M8	98	10
BA10100	BAC10100	12	M10	100	10
BA12115	BAC12115	14	M12	115	10

(*) Su richiesta si possono fornire lunghezze diverse

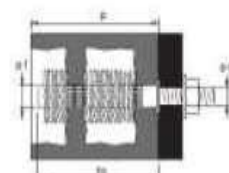

Tassello a rete per chimico

Art. nr.	$\varnothing f \times h s$	$\varnothing b$	P (mm)	pz/imballo
R12	12x85	M6-M8	95	10
R16	16x85	M8-M10	95	10
R20	20x130	M12-M16	140	10



Miscelatore universale per ancorante chimico

Art. nr.	\varnothing	pz/imballo
MS1	9mm	2

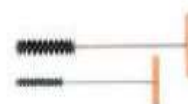

Scovolini per pulizia foro

Art. nr.	\varnothing setole	pz/imballo
SC2	14/20mm	1+1



Pistola professionale in metallo

Art. nr.	pz/imballo
PS1	1



Pompetta per pulizia fori

Art. nr.	pz/imballo
P1	1

9 Accessori uso e manutenzione

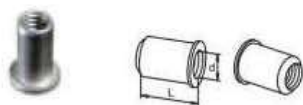

Inserti filettati inox

Art. nr.	d	L	Punta	pz/imballo
IM6	M6	13,8	Ø9,0	15
IM8	M8	15,7	Ø11,0	15



Anelli decorativi in nylon

Art. nr.	Ø	colore	H	pz/imballo
330	42,4x2,0	nero	3 mm	10
333	42,4x2,0	blu	3 mm	10



Adesivo liquido speciale per acciaio inossidabile dotato di dosatore.

Adesivo speciale per acciaio inox

Art. nr.	contenuto	nr° applicazioni	pz/imballo
320	50ml	40-60	1



Spray per la manutenzione e la protezione dell'acciaio inossidabile.

Spray cleaner pulisciaio protettivo

Art. nr.	contenuto	pz/imballo
321	400ml	1

ESEMPIO DI UTILIZZO DEGLI INSERTI

FISSAGGIO SERRAVETRO CON INSERTO M8 (Art. IM8)

- 1 Praticare il foro al tubolare con punta per acciaio inossidabile come da tabella.
- 2 Alloggiare l'inserto M8 con apposito utensile.
- 3 Inserto M8 correttamente alloggiato nella sua sede.
- 4 Avvitare la vite in dotazione nell'apposito rivetto passando attraverso la parte di serravetro da fissare al tubo.
- 5 Inserire l'apposita guarnizione in gomma EPDM.
- 6 Appoggiare la lastra di vetro contro le quattro parti fisse e serrarlo con le parti rimanenti usando le apposite viti in dotazione.

FISSAGGIO COLLA ADESIVA - INOX

Dal Grafico qui a lato si evince che vi è una correlazione diretta tra temperatura d'esercizio e incollaggio dell'adesivo.

All'aumentare della temperatura diminuisce il tempo relativo di fissaggio adesivo-inox.

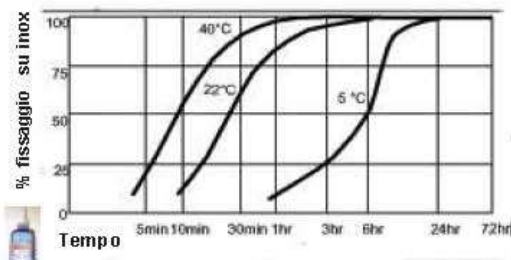



10

INOX SERVIZI



- **PRONTO KIT**
- **CURVATURA TUBI e TONDI**
- **TAGLIO TUBI e TONDI**

PRONTO KIT

Preparazione presso la nostra officina attrezzata dei montanti pronti ad essere posati in opera. Il preventivo si intende completo di tutti gli accessori come da disegno (esclusi i tappi di chiusura superiori ed eventualmente inferiori e/o sostegni per corrimano superiore).

N.B: Il kit per motivi logistici verrà confezionato sfuso per essere assemblato sul luogo di destinazione.

CURVATURA TUBI e TONDI

Curvatura e calandratura di tubi ($\varnothing 33,7$ - $\varnothing 42,4$ - $\varnothing 48,3$ mm) e tondi pieni ($\varnothing 10$ - $\varnothing 12$ mm) secondo i dati da Voi forniti compilando il modulo predisposto. (2D)= curvatura (3D)= curvatura e calandratura.

SERVIZIO DI TAGLIO TUBO e TONDO

Si effettuano tagli delle barre nelle misure indicate.

10 PRONTOKIT TIPO T[©]









A pavimento

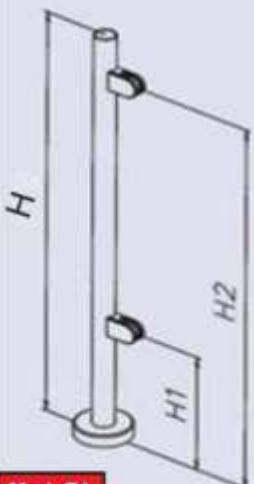



33,7 x 2,0

304

42,4 x 2,0

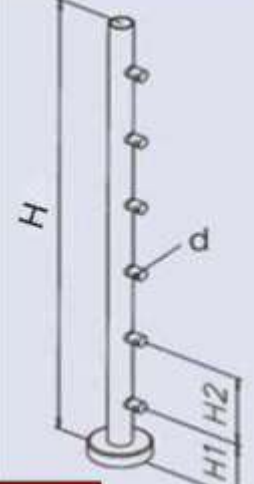
316

 <p>Mod. T1</p>	<p>H: _____ mm H1: _____ mm H2: _____ mm</p>	<p>Tipo Type</p>	<p>Quantità Quantity</p>
	<p>Base Basement</p> <p><input type="checkbox"/> 020D33* <input type="checkbox"/> 020D42 <input type="checkbox"/> 010</p> <p>Serravetro Glass Clamp type</p> <p><input type="checkbox"/> 260* <input type="checkbox"/> 270* <input type="checkbox"/> 262 <input type="checkbox"/> 272</p>	<p>Spessore vetro Glass thick</p> <p><input type="checkbox"/> 6 mm <input type="checkbox"/> 6,76 mm <input type="checkbox"/> 8 mm <input type="checkbox"/> 8,76 mm <input type="checkbox"/> 9,52 mm <input type="checkbox"/> 10 mm <input type="checkbox"/> 10,76 mm <input type="checkbox"/> 11,52 mm <input type="checkbox"/> 12 mm <input type="checkbox"/> 12,76 mm</p>	<p><input type="checkbox"/> </p> <p><input type="checkbox"/> </p> <p><input type="checkbox"/> </p> <p><input type="checkbox"/> </p> <p><input type="checkbox"/>  W = ____°</p> <p><input type="checkbox"/>  W = ____°</p> <p><input type="checkbox"/> </p>

 <p>Mod. T2</p>	<p>H: _____ mm H1: _____ mm H2: _____ mm</p>	<p>Tipo Type</p>	<p>Quantità Quantity</p>
	<p>Sostegno per correnti Bar tube holder</p> <p>d:</p> <p><input type="checkbox"/> 10 mm <input type="checkbox"/> 12 mm</p> <p>Base Basement</p> <p><input type="checkbox"/> 020D33* <input type="checkbox"/> 020D42 <input type="checkbox"/> 010</p> <p>Nr. _____ File sostegni Pieces per vertical unit</p>	<p><input type="checkbox"/> </p> <p><input type="checkbox"/> </p> <p><input type="checkbox"/>  W = ____°</p>	

Laterale

PRONTOKIT TIPO L[©]

10

33,7 x 2,0

42,4 x 2,0

48,3 x 2,0

304

316

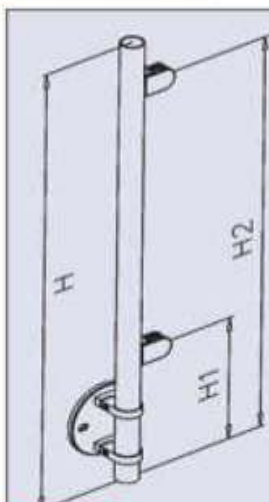

Mod. L1

H: _____ mm

H1: _____ mm

H2: _____ mm

Piastra laterale

Side plate type

103D33*

103D42

101
(solo aisi 304)

Serravetro

Glass Clamp type

260* 270*

262 272

263 273

Spessore vetro

Glass thick

6mm 13,52 mm

6,76mm 15 mm

8 mm 16,76 mm

8,76 mm 17,52 mm

9,52 mm

10 mm

10,76 mm

11,52 mm

12 mm

12,76 mm

Tipo

Type

Quantità

Quantity

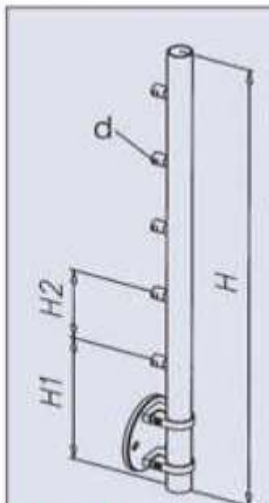

Mod. L2

H: _____ mm

H1: _____ mm

H2: _____ mm

Sostegno per correnti

Bar tube holder

d:

10 mm

12 mm

Piastra laterale

Side plate type

103D33*

103D42

101 *(solo aisi 304)*

Nr. _____ **file sostegni**

Pieces per vertical unit

Tipo

Type

Quantità

Quantity



10 CURVATURE ©

Modulo A

	Aisi 304	Aisi 316	R min.
● Ø 10 mm	<input type="checkbox"/>	<input type="checkbox"/>	250 mm
● Ø 12 mm	<input type="checkbox"/>	<input type="checkbox"/>	250 mm
○ Ø 12x1,5 mm	<input type="checkbox"/>	<input type="checkbox"/>	250 mm
○ Ø 33,7x2,0 mm	<input type="checkbox"/>	<input type="checkbox"/>	500 mm
○ Ø 42,4x2,0 mm	<input type="checkbox"/>	<input type="checkbox"/>	500 mm
○ Ø 48,3x2,0 mm	<input type="checkbox"/>	<input type="checkbox"/>	500 mm

